

**Agenda**  
**Tuscola County Board of Commissioners**  
**Committee of the Whole Monday, February 22, 2021 – 8:00 A.M.**  
**HH Purdy Building - 125 W. Lincoln, Caro, MI**

**RESIDENTS OF TUSCOLA COUNTY PLEASE TAKE NOTICE**

Electronic remote access will be implemented for this meeting, in accordance with the Department of Health and Human Services Emergency Order Under MCL 333-2253 Gathering Prohibition and Mask Order and Public Act No. 254 of 2020.

**To participate in the Electronic Meeting you can:**

***Join by phone:*** (US) +1-315-933-0357 PIN: 767 754 066##

***Join by Hangouts Meeting ID*** [meet.google.com/qig-rhvk-ghy](https://meet.google.com/qig-rhvk-ghy)

**8:00 A.M. Call to Order – Chairperson Bardwell**  
**Roll Call – Clerk Fetting**

**County Updates**

Ann Hepfer, Health Officer

**New Business**

1. Courthouse X-Ray Machine Maintenance Agreement Renewal – Steve Anderson, Emergency Services Coordinator (**See A**)
2. Economic Development Commission Working Projects (**See B**)
3. COVID19 Medical Claims Dashboard (**See C**)

**Old Business**

1. State Land Bank – Maps (**See D**)
2. Board Rules – On going – Conflict Policy Creation
3. RFP Building Codes – Under Review
4. Cost Allocation Plan (CAP) – Under Review
5. MREC - Updates

**Finance/Technology**  
Committee Leader **Commissioner Young** and Commissioner DuRussel

**Primary Finance/Technology**

1. 2022 County Revenue Sharing Projections Executive Recommendation (**See E**)

**On Going and Other Finance and Technology**

**Finance**

1. Fund Balance History Reports
2. Preparation of Multi-Year Financial Planning

**Technology**

1. GIS Update
2. Increasing On-Line Services/Updating Web Page

**Building and Grounds**

Committee Leader Commissioner DuRussel and Commissioner Grimshaw

**Primary Building and Grounds**

1. Lawn Mowing Services
2. Health Department Retention Pond Repair Bids

**On Going and Other Building and Grounds**

1. State Police Building-Water and Annexation

**Personnel**

Committee Leader **Commissioner Grimshaw** and Commissioner Vaughan

**Primary Personnel**

1. Central Dispatch Refill Vacant Position – Sandy Nielsen, Dispatch Director (**See F**)
2. County Clerk Staff Appointment, Jodi Fetting, County Clerk
3. Behavioral Health Systems Board Appointments (**See G**)
4. Tuscola County Land Bank Board Appointment (**See H**)

### **On-Going and Other Personnel**

1. MAC 7<sup>th</sup> Meeting Updates
2. Work Comp Updates – Training Meetings Being Scheduled
3. Safety Committee's

### **Other Business as Necessary**

1. Formation of Legislative Committee with Commissioners and Possibly Huron County

### **On-Going Other Business as Necessary**

1. Animal Control Ordinance

### **Public Comment Period**

## Courthouse X-Ray Machine Maintenance Agreement Renewal

### History:

The existing x-ray machine was purchased from Event Metal Detectors/X-Ray Machines in December 2013 in the amount of \$25,600.00. The project was funded entirely with a Homeland Security grant.

Court Security uses the x-ray machine Monday through Friday while the courthouse is open to the public. (Obviously Covid has changed this practice)

Since being in operation, we have utilized the service contract on several occasions to repair the x-ray machine. To date, we have replaced the belt, rollers, on board computer, had misc repairs made to the control panel, and other components.

With the many mergers with L-3/Harris and the initial service technician leaving the company, it has been increasingly difficult to work with our existing x-ray machine vendor for maintenance and servicing. This, along with the ever increasing cost of the annual maintenance contract I attempted to get some additional options for the Board to consider.

### Option A: Continue with L-3/Harris which is now Leidos

- L-3/Harris was purchased by Leidos at some point in 2020.
- I requested a quote for the annual service agreement for the existing x-ray machine and was able to get one after learning that the company was bought out and their email addresses were changed. For one year of coverage (March 25, 2021 thru March 24, 2021) the price was quoted at \$5,800.00.
- This is an increase from the \$5,500.00 that we paid last year.
- To date we have paid (2016-2020) \$24,500.00 for the annual service contract.

### Option B: VOTI Detection

- Provided pricing on two different units
  - XR3D-50s: Total with 5 yr service contract & training = \$42,260.00
  - XR3D-60s: Total with 5 yr service contract & training = \$44,610.00
- Also provided leasing pricing for both units as well
  - XR3D-50s:
    - 36 month:
      - \$1,088.20 per month (\$13,058.40 per year / 3 yr total \$39,175.20) with a buyout of 15.5% (\$6,550.30)
      - \$1,272.45 per month (\$15,269.40 per year / 3 yr total \$45,808.20) with a buyout of \$1.00
    - 60 month:

- \$710.39 per month (\$8,524.68 per year / 5 yr total \$42,623.40) with a buyout of 10.1% (\$4,268.26)
    - \$785.61 per month (\$9,427.32 per year / 5 yr total \$47,136.60) with a buyout of \$1.00
  - XR3D-60s:
    - 36 month:
      - \$1,148.71 per month (\$13,784.52 per year / 3 yr total \$41,353.56) with a buyout of 15.5 % (\$6,914.55)
      - \$1343.21 per month (\$16,118.52 per year / 3 yr total \$48,355.56) with a buyout of \$1.00
    - 60 month:
      - \$749.89 per month (\$8,998.68 per year / 3 yr total \$44,993.40) with a buyout of 10.1% (\$4,505.61)
      - \$829.30 per month (9951.60 per year / 5 yr total \$49,758.00) with a buyout of \$1.00

Option C: MSA Security

- Provided pricing on two different units
  - HI-SCAN 5030si with 3 yr service contract \$36,312.00
  - HI-SCAN 6040ds with 3 yr service contract \$48,356.00
- Leasing was not available because of COVID

Option D: Point Security, Inc

- Provide service for several makes/models of x-ray machines. Was advised that they no longer service L-3/Harris as they had difficulty in receiving parts from the manufacturer in a timely manner. Phased out all service contract with L-3/Harris machines in the last year
- Provided pricing on two different units
  - Smith Detection 5030si with 5 yr service contract \$40,010.00
  - Smith Detection 6040ds with 5 yr service contract \$43,754.00
- Also provided leasing pricing for both units as well for a 60 month/5 yr lease
  - Smith Detection 5030si or the 6040ds: \$9,000.00 per year / 5 year total \$45,000.00

Option E: Autoclear, LLC

- I spoke with a salesperson who recently dealt with Lapeer County, Greg Schaefer. Greg advised they do not service L-3/Harris machines but knows someone who might who is based out of Chicago.
- I was contacted by Sal Leanos, owner of Advance Security Resources. After sending the information about the current x-ray machine we own, he declined to service the machine, citing that the parts are currently being shipped from China.

- I was supposed to receive a quote/proposal from Autoclear/Advance Security Resources, but as of yet, I have not received anything.



January 14, 2021

Tuscola County Courthouse  
Attn: Deputy Steven Anderson  
420 Court Street Suite 1  
Caro, MI 48723  
Phone: 989-673-5181  
Email: [Sanderson@tuscolacounty.org](mailto:Sanderson@tuscolacounty.org)

Re: Select Schedule Annual Maintenance Contract Proposal No. S-03-25-2021

Dear Mr. Anderson,

Leidos Security Detection & Automation, Inc., is pleased to provide the attached proposal for equipment maintenance on your x-ray systems with a period of coverage of March 25, 2021 Thru March 24, 2022. We value your business and look forward to receiving your acceptance documentation soon.

Please review the attached proposal and verify the following information:

- Billing address for your invoice
- Delivery address
- Method of payment
- Model description, serial number, and location of system

If you do not issue purchase orders, by signing this document, you have acknowledged our proposal and agree to enter into a maintenance contract with Leidos Security Detection & Automation, Inc., and this document will serve as a purchase order. We will respond via fax, mail, or e-mail with your Contract ID for your records.

If you have any questions please feel free to contact me directly at your convenience. Should any repairs or adjustments be required to your equipment in between the regular scheduled preventative maintenance visits please contact our 24x7 Service Center directly at 1-800-776-3031.

Sincerely,

Lillian Castro-Pena  
Contracts Department  
Leidos Security Detection & Automation, Inc.  
[Lillian.Castro-Pena@Leidos.com](mailto:Lillian.Castro-Pena@Leidos.com)  
Phone: 781-970-1606-Working Remote  
Cell: 781-779-7962

**Leidos Proprietary**



|  |  |  |
|--|--|--|
| <b>BILLING ADDRESS:</b><br>Tuscola County Courthouse<br>420 Court Street Suite 1<br>Caro, MI 48723 | <b>DELIVERY ADDRESS:</b><br>Tuscola County Courthouse<br>440 N. State Street<br>Caro, MI 48723 | <b>PROPOSAL NO:</b> S-03-25-2021<br><b>ATE OF PROPOSAL:</b> 01/14/2021<br><b>PROPOSAL VALID FOR:</b> 90 DAYS<br><b>TTACHMENTS:</b> 8100-11901-00 and<br>100-11902-00 |
|--|--|--|

**SELECT SCHEDULE ANNUAL EQUIPMENT MAINTENANCE CONTRACT PROPOSAL**

**SCHEDULE OF SERVICES PROVIDED UNDER THIS CONTRACT:**

- All necessary repair parts and freight related expenses.
- Regular (Monday-Friday, 8:00am-5:00pm) labor hours for remedial maintenance.
- Regular (Monday-Friday, 8:00am-5:00pm) travel time to and from the equipment site.
- Lodging, Airfare and Per Diem expenses as required per scope of repairs.
- One annual preventative maintenance inspection per x-ray system \*
- One annual radiation safety survey and preparation of performance report per x-ray system \*
- Additional services are available upon request at Seller's prevailing time and materials rates.

\* Note: Metal Detectors do not receive preventative maintenance or radiation survey services.

**COVERAGE PERIOD:** March 25, 2021 thru March 24, 2022

**PAYMENT TERMS:** Annual billing, in Advance, payment net 30 days after delivery of Seller invoice

**ACCEPTED FORMS OF PAYMENT:** Business check, Wire Transfer, Credit Card

**CONTRACT TERMS AND CONDITIONS AND STATEMENT OF WORK:** The terms and conditions and statement of work governing this contract are detailed on attached documents 8100-11901-00 and 8100-11902-00 herein. These seller terms and conditions shall take precedence over any and all others incorporated by the Buyer.

**EQUIPMENT TO BE SERVICED UNDER THIS CONTRACT:** SEE PAGE NO. THREE (3) FOR DETAILS.

| Item | Model Number | Serial Number | Unit Price | Shipping Location                  |
|------|--------------|---------------|------------|------------------------------------|
| 1    | PX5.3        | PX530152      | \$5,800    | 440 N. State Street Caro, MI 48723 |

**TOTAL ANNUAL PRICE:** \$5,800 plus tax if applicable - See document no. 8100-11901-00, clause no. ten (10) for details.

Please reference proposal no. S-03-25-2021, unit serial number(s) and period of performance on your purchase order.

If you do not issue purchase orders, by signing this document, you have acknowledged our proposal and agree to enter into a maintenance contract with Leidos Security Detection & Automation, Inc. This document will serve as a purchase order. We will respond via fax, mail, or e-mail with your Contract ID for your records.

Contact Lillian C. Pena concerning order placement via Phone: 781-970-1606 -or- e-mail [Lillian.Castro-Pena@Leidos.com](mailto:Lillian.Castro-Pena@Leidos.com)

**BUYER PURCHASE ORDER NUMBER:** \_\_\_\_\_ **CONTRACT ID:** \_\_\_\_\_

**AUTHORIZED SIGNATURE REQUIRED:**

**TUSCOLA COUNTY COURTHOUSE:**

Name: \_\_\_\_\_  
 Title: \_\_\_\_\_  
 Signature: \_\_\_\_\_  
 Date: \_\_\_\_\_

**LEIDOS SECURITY DETECTION & AUTOMATION, INC.:**

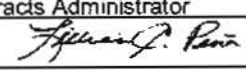
Name: Lillian Castro-Pena  
 Title: Contracts Administrator  
 Signature:   
 Date: January 14, 2021

**Leidos Proprietary**





## ANNUAL EQUIPMENT HARDWARE MAINTENANCE CONTRACT TERMS AND CONDITIONS

Document No. 8100-11901-00

1. **Cross Indemnification:** Leidos Security Detection & Automation Inc., hereinafter referred to as Seller, shall indemnify, defend and hold Buyer harmless from and against any losses, damages, expenses, liabilities, and costs arising out of the negligence of Seller, its employees, or agents in performing services under this Agreement. Buyer shall indemnify, defend and hold Seller harmless from and against any losses, damages, expenses, liabilities, and costs arising out of the negligence of Buyer, its employees, or agents with respect to the use or operation of the System.
2. **Cancellation during the contract period:** If Buyer cancels this Agreement pursuant to Section three (3) or if newly purchased equipment supplied by Seller replaces the equipment under this contract, Buyer may cancel this contract without charge by giving written notice to Seller. In the case of a cancellation for any other reason, Buyer must provide Seller ninety (90) days' prior written notice of cancellation or pay Seller 25% of any remaining annual contract fee as liquidated damages. Seller also reserves the right to cancel this Agreement without penalty if Buyer is in default and fails to cure within 30 days following receipt of written notice of default.
3. **Cancellation for cause:** Buyer retains the right to cancel this contract immediately and without advance notice to Seller should Seller's services be unsatisfactory in quality or should Seller fail to perform in accordance with the statement of services for any reason within Seller's control. In the event of such cancellation, Buyer will notify Seller in writing. Buyer will pay only for the services rendered up to the date that Seller receives the written cancellation notice.
4. **LIMITATION OF LIABILITY:** REGARDLESS OF THE LEGAL OR EQUITABLE BASIS OF ANY CLAIM, IN NO EVENT WILL SELLER BE LIABLE FOR (i) ANY SPECIAL, INDIRECT, INCIDENTAL OR CONSEQUENTIAL DAMAGES, INCLUDING WITHOUT LIMITATION, ANY DAMAGES RESULTING FROM INACCURATE OR LOST DATA, LOSS OF USE OR LOSS OF REVENUES OR PROFITS, ARISING OUT OF OR RELATING TO THIS AGREEMENT OR ANY ORDER, THE FURNISHING OF PRODUCTS AND SERVICES OR THE USE OR PERFORMANCE OF PRODUCTS OR SERVICES, EVEN IF INFORMED OF SUCH DAMAGES, OR (ii) FOR ANY THIRD PARTY CLAIMS AGAINST CUSTOMER. SELLER'S MAXIMUM LIABILITY UNDER ANY ORDER, INCLUDING LIABILITY ARISING OUT OF PRODUCTS DELIVERED, SERVICES PERFORMED OR FROM SELLER'S NEGLIGENCE OR OTHER ACTS OR OMISSIONS, WILL BE LIMITED TO THE AMOUNT PAID TO SELLER FOR THE PRODUCTS AND/OR SERVICES GIVING RISE TO THE CLAIM.
5. **Alterations:** Buyer shall have the right to request that systems be returned to service coverage on a pro-rated basis. Prior to systems being returned to service coverage all systems are subject to billable pre-inspection services to be performed by the Seller. The Seller's prevailing standard service rates shall be used to calculate the pre-inspection services.
6. **Software:** Unless otherwise expressly agreed in writing to the contrary, all technical specifications, software, technical information, source code, drawings, and/or Data provided to Buyer by the Seller, or used by the Seller in updating, upgrading or performing repairs to the Buyer's equipment, shall remain the sole property of the Seller. Any use of said data and software shall constitute use under a limited use license only. This License is expressly limited to the functionality of individual items of Seller equipment previously purchased by the Buyer.
7. **Exclusions:** Contractual coverage shall not apply to any equipment, spare parts, or services that are: (a) repaired, moved or modified other than by Seller's authorized personnel; or (b) subjected to physical or electrical abuse, stress, or misuse; or (c) stored, operated, modified, or maintained in a manner inconsistent with applicable Seller instructions and specifications. No third party agents, regardless of affiliation or former affiliation with Seller, retain the rights to perform service actions under this contract. Also excluded from this contract are parts, materials, and other ancillary equipment which have been damaged due to improper handling; power surges, exposure to the elements of extreme heat, extreme cold, moisture; acts of nature such as rain, sleet, snow, earthquakes, lightning, hurricane, etc.; equipment failures resulting from installation or operation or use in any manner not in accordance with Seller instructions; failures resulting from installation or operation or use in any manner not in accordance with Seller instructions; equipment damage due to misuse or abuse (through negligence, accident, or vandalism); erroneous reports by Buyer of equipment failures; and equipment which has been repaired or modified without the written approval of Seller.
8. **Accessories and Attachments:** Service actions performed by Seller under this contract will not include maintenance or repair of accessories, attachments, machines, or other similar devices not originally supplied or provided by Seller; painting or refinishing of equipment or providing such painting or refinishing materials; or furnishing supplies, accessories, or other similar devices except as specifically required for equipment repair or maintenance.
9. **Special Cancellation:** The specific equipment covered by this contract shall be serviced as needed and all required spare parts shall be provided unless stock is no longer available due to end of life issues. Seller shall make a best commercial effort to support this equipment during the contractual period and make provisions for end of life parts. Should services be required and spare parts are no longer available, Seller shall make a best commercial effort to render Buyer's equipment back into operating condition. If Seller is unable to bring the up to operating condition, the affected equipment shall then be removed from the remainder of the contract and a pro-rated credit for the balance of the present contract term shall be issued. Credits shall be sent out within thirty (30) days of cancellation. Also, the affected equipment shall not be included in future contract renewals or during any remaining optional years.
10. **Taxes:** This quotation does not include taxes. Taxes levied against Seller as a result of products offered or sold hereunder and any services rendered in connection therewith, including but not limited to installation or maintenance would be additional cost and shall be reimbursable by Purchaser upon submittal of supporting documentation of such costs.
11. **Acceptance of Buyer's Terms and Conditions:** Any resultant Contract/Purchase Order with Terms and Conditions other than these shall not be accepted without notice provided to Buyer accepting all or a portion of the Buyer's Terms and Conditions. Estimates are calculated under these Terms and Conditions and pricing may change for compliance with alternative Terms and Conditions as well as the schedule.

## ANNUAL EQUIPMENT HARDWARE MAINTENANCE CONTRACT STATEMENT OF WORK

Leidos Proprietary

1. **Response Time:** Leidos Security Detection & Automation Inc., hereinafter referred to as Seller, will provide response as soon as possible to requests for equipment service from Buyer's authorized representative. 8-hour Seller response time will be typical in geographical locations where Seller has resident service engineers. 24-hour Seller response time will be typical in geographical locations where Seller does not have resident service engineers. Seller does not warrant that the use of equipment will be uninterrupted or error free.
2. **Seller Responsibilities:** As applicable to the specific maintenance contract schedule, service actions performed by Seller will include all parts, materials, and labor required to adjust, maintain, repair, or restore the equipment to proper operating condition in accordance with the manufacturer's specifications. Seller will not perform any modifications to the equipment without Buyer's written approval. Seller will perform all service actions at the equipment site whenever possible and practical. Seller will perform all service actions with the least possible interference or disruption to the orderly conduct of Buyer's normal operations. Upon the completion of service, Seller will leave Buyer's premises in as neat, orderly, and clean condition as existed upon start of services. Seller will be responsible for obtaining all air side passes, work permits, clearances, and required licenses. Seller will be responsible for compliance with all laws, codes, rules, and regulations applicable to services performed under this contract. Seller will not transfer or assign its obligations under this contract, either in whole or in part, without the prior written approval of Buyer.
3. **Buyer Responsibilities:** Buyer will provide adequate facilities for Seller's personnel. The facilities will include adequate workspace, heat, lighting, ventilation, proper electrical current, and earth grounded electrical outlets. The facilities will be located within a reasonable distance from the equipment being serviced and will be provided by Buyer at no cost to Seller. Seller will not be responsible for Buyer's failure to provide prompt access to the equipment or to adequate facilities.
4. **Additional Services:** Upon agreement between Buyer and Seller, Seller may perform additional services beyond Seller's obligations under this contract. Such services may include, but are not limited to, equipment installation, relocation, and re-installation. All such services, when performed, will be invoiced to Buyer in accordance with Seller's prevailing standard service rate schedule.
5. **Service Call Report (SCR):** Upon completion of service, Seller's service engineer will submit the SCR to Buyer's authorized representative. The SCR will itemize the service actions performed. Buyer's authorized representative will be provided with a copy of the completed and signed SCR. Should Buyer fail to have an authorized representative on site for any reason upon completion of Seller's services, the lack of Buyer's authorized representative's signature on the SCR will not be a basis for claiming that unsatisfactory service was provided by Seller.
6. **Spare Parts and Materials:** All spare parts and materials provided and or replaced by the Seller, regardless if they are new; factory refurbished, rebuilt, restored, renovated or reconditioned, shall be warranted for ninety (90) days from the date of installation. Seller reserves the right to use Like-Kind-Quality spare parts and materials including new, factory refurbished, rebuilt, restored, renovated or reconditioned items. Any use of alternate spare parts and materials shall have no effect on the Form, Fit, and Function of said parts and materials and shall be warranted for ninety (90) days from the date of installation, or the remaining life of the contract, whichever is longer.
7. **Annual Preventative Maintenance for X-ray Systems:** Listed below are the procedures that our technicians perform during the annual contract period.

### **ANNUAL PREVENTATIVE MAINTENANCE FOR X-RAY SYSTEMS**

#### **VISUAL AND MECHANICAL:**

- Vacuum system interior and exterior
- Inspect conveyor rollers
- Inspect condition of conveyor belt and lacing
- Adjust conveyor belt tension and tracking
- Inspect condition of x-ray sensor dust shields
- Inspect for x-ray generator oil leakage
- Align and clean optical sense modules
- Test indicator lamps for proper operation

#### **OPERATIONAL SAFETY:**

- Inspect AC line cord for damage and test for proper grounding
- Inspect finger guards and/or pop-out rollers for damage
- Verify conveyor under panels are securely attached
- Test emergency stop switches

#### **ELECTRONIC:**

- Adjust x-ray tube voltage and current
- Test operator control panel functions
- Adjust monitors
- Inspect conveyor relays
- Adjust power supply voltages
- Collimate x-ray beam
- Verify x-ray image quality & resolution

#### **RADIATION SAFETY:**

- Measure radiation dose per inspection (annual), test all safety interlocks for proper operation
- Measure external radiation emissions (annual)
- Test all "x-ray on" indicators for proper operation
- Inspect condition of lead curtains
- Inspect operator footmat for condition and test for proper operation
- Preparation of radiation performance report per x-ray system



Main Phone: 781-939-3800

## Payment / Remittance Information Please Update Your Records

### **\*\*Correspondence and PO Address:**

Leidos Security Detection & Automation, Inc.  
One Radcliff Road  
Tewksbury, MA 01876

### **Check Remittance Address: (for check payment only)**

Leidos Security Detection & Automation, Inc.  
21867 Network Place  
Chicago, IL 60673 – 1218

**\*\*This address must be listed as the vendor address on your PO. Purchase Orders and other correspondence (EXCLUDING PAYMENTS) should be sent to Tewksbury, MA**

### **PLEASE BE SURE TO NOTE INVOICE REMITTANCE INFORMATION ON ALL PAYMENTS**

For accurate and timely processing of transactions, it is very important that remitters correctly identify the company account number and the applicable routing number.

#### **For delivery via regular US postal service:**

Lockbox Name: LEIDOS SECURITY DETECTION & AUTOMATION, INC.  
Lockbox Address: 21867 Network Place Chicago, IL 60673-1218

#### **For ACH delivery:**

Bank Routing Number: 071000013  
Account Number: 656511029  
Account Name: LEIDOS SECURITY DETECTION & AUTOMATION, INC

#### **For Wire Transfers:**

Bank Routing Number: 021000021  
SWIFT Code: CHASUS33  
General Bank Reference Address: JPMorgan Chase New York, NY 10017  
Account Number: 656511029  
Account Name: LEIDOS SECURITY DETECTION & AUTOMATION, INC

#### **For delivery via overnight courier service:**

Lockbox Name: LEIDOS SECURITY DETECTION & AUTOMATION, INC.  
Lockbox Address: Attn: LBX 21867  
131 S Dearborn, 6th Floor Chicago, IL 60603

F.I.D. Number: 04-3054475  
DUNS Number: 11-275-3194  
CAGE CODE: 1VGC6  
Other Instructions: Please reference our invoice number(s).

**Leidos Proprietary**



# Proposal for X-Ray Scanner

Prepared for:  
Tuscola County, MI



VOTI Detection, January 2021

## CONTACT INFORMATION

Jonathan Feist  
National Account Manager  
VOTI Detection  
jonathan.feist@votidetection.com  
+1 514.242.5966

January 6, 2021

Tuscola County, MI  
Deputy Steven Anderson

Dear Deputy Anderson,

VOTI Detection is offering best in class technology and stands ready to provide Tuscola County with technologically advanced and reliable checkpoint screening equipment to support your critical operations.

VOTI wants to develop its long-term relationship with the County and help fulfill its mission of providing a system of justice by ensuring safe and secure facilities. As such, we are working hard to offer the best value-for-money options available, and pride ourselves in our open and honest approach, quality product range and best in class service and support.

We have been steadily growing our footprint in the U.S. since 2010, installing in countless courthouses and other critical infrastructures. We have proven ourselves as the preferred X-ray provider for a number of marquee customers: Amazon, the NFL, Tiffany's, the NBA, the United Nations, Disney, Carnival, and Prudential Bank all trust VOTI for their most critical security mandates.

Since this package to the County aims to be concise in detail, should you wish for any specific documentation or information not provided here, please do not hesitate to contact me and I will respond with the highest of urgency.

Kind regards,

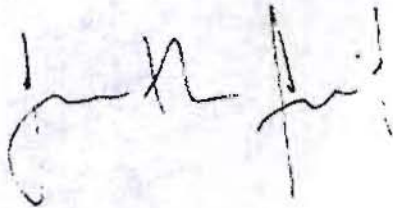

Jonathan Feist  
National Account Manager  
VOTI Detection  
790 Begin St.  
St-Laurent, (Québec) Canada  
H4M 2N5  
jonathan.feist@votidetection.com  
Mobile: + 1-514-242-5966

## Key Differentiators

VOTI recommends its XR3D-60s and XR3D-50s MATRIX 3D Perspective X-Ray scanner and responsive service team to fulfil the County's security mandate.

- Our responsive service team sets us apart: rather than focus on large + service-heavy federal contracts, we focus our energy into smaller deployments, as attention to the needs of our customers is our first priority.
- VOTI's higher resolution images, full touchscreen display, and unique 3D Perspective provide a superior visual to the operator to ensure the highest level of threat detection.
- VOTI's commitment to industry-leading support and customer service will guarantee performance.
- Powerful performance metrics: steel penetration, wire resolution, and special resolution are industry-leading (see Spec sheets for details).
- VOTI's remote diagnostic capabilities allows for the root cause of software or hardware issues to be determined without the need for a technician on-site.
- VOTI's short conveyor model (XR3D-60s and XR3D-50s) considers the space constraints in Courthouse deployments.
- VOTI's adaptable and remote update software architecture will allow the County to meet security threats that arise in the coming years. With capabilities for major software advancements: **any major software advancement can be installed in units which are already in the field.**
- VOTI's auto-seasoning allows for autonomous software-driven tuning when necessary. This avoids on-site service calls and avoids any down time. Unlike our competitors which may require a "regeneration" if a unit is out of use for 60-90 days, VOTI automatic seasoning eliminates the need to send a technician onsite and gets the machine up-and running automatically.

## The VOTI Difference

Our equipment and software are easy to use and highly customizable, our remote diagnostics and troubleshooting significantly reduce downtime, and our raw image processing provides centralized security screening, archiving and the possibility for future scanning review.

- **Modern Software-based Architecture**
  - 7 main components (instead of 20+)
  - Fewer parts means lower potential points of failure and lower cost of ownership
  - VOTI scanners can be easily upgraded to keep up with developments
  - Our MATRIX series scanners perform to the highest levels when compared to the competition (steel penetration and wire resolution)
  
- **Clear 3D Perspective X-Ray Images**
  - VOTI scanners can produce 3D Perspective images from a single X-Ray source
  - Reduction of blind spots means more information for operators to make the right decision
  
- **Full-Feature Touchscreen Control**
  - Improved user experience, including “pinch-zoom” (as experienced on a mobile device)
  - Ergonomic, intuitive: operators have access to wide range of features, all in one place
  - Intuitive touchscreen interface improves operator performance and reduces onboarding time
  
- **Remote Support Capabilities**
  - Remote Diagnostics & repair at no additional cost
  - Quick resolution time or work-around
  - Enables identification of spare parts required immediately (if needed), reducing downtime
  
- **Dedicated Account Manager and Support Staff**
  - For any service issue, our support line is open 24/7 to support you. All service support coming from our headquarters in Montreal, Canada.
  - For all other inquiries, from planning logistics to finding the right solutions for your needs, ONE dedicated account executive (Jonathan Feist) will always be your point of contact

## VOTI's 3D Perspective™ Technology

3D Perspective employs advanced geometrics and distortion-correcting algorithms to remove blind spots and increase the visibility of threats. 3D Perspective maximizes the screening area to produce images of unparalleled depth and detail, allowing operators to quickly identify threats. *We allow operators to see what competitors' 2D solutions find challenging or take multiple re-scans and image manipulation to identify.*

### 3D Perspective: What isn't the Competition Seeing?

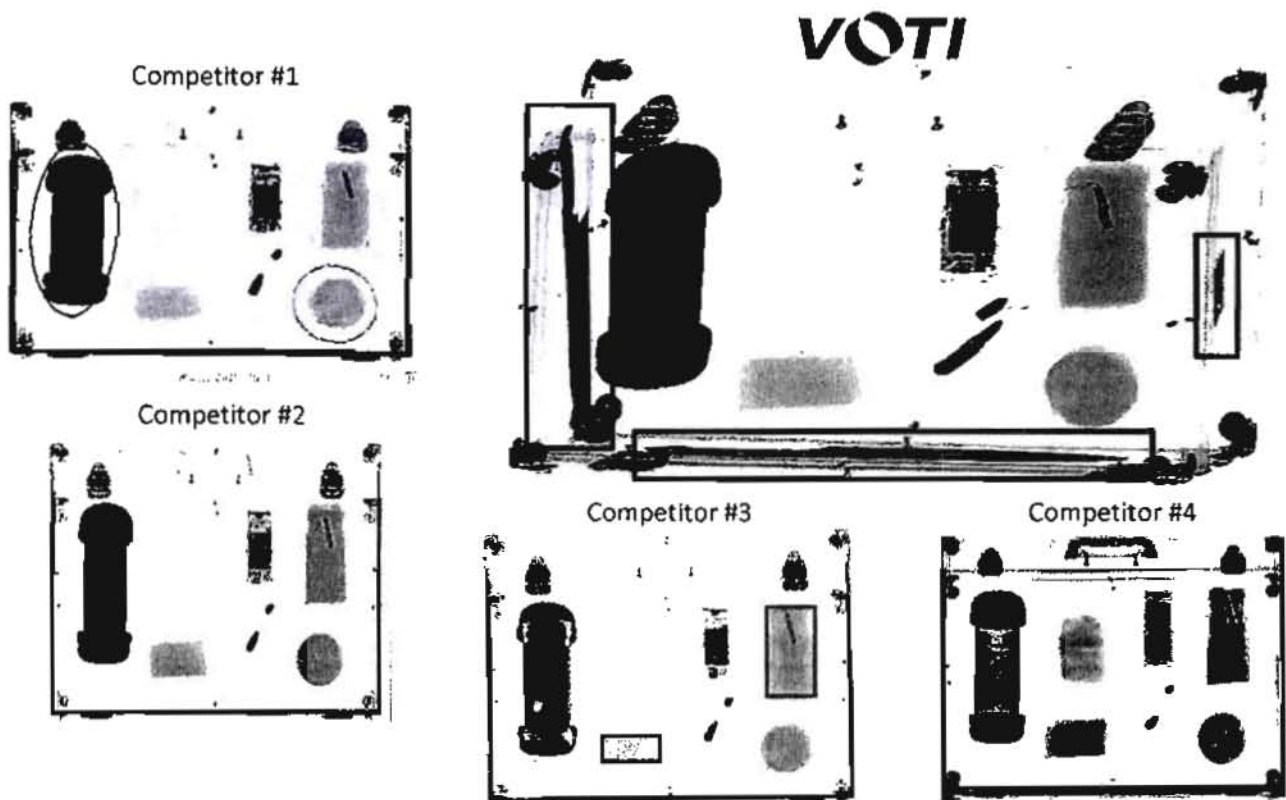

As seen in the comparison image above, VOTI's 3D Perspective image is noticeably clearer and more detailed, **revealing threats not normally visible** in conventional systems. Cleverly placed knives, guns, and other hazardous or contraband materials can be hidden from view in the seams of a suitcase and missed by operators that do not perform a manual search. With VOTI's XR3D scanners, concealed items are made obvious – a technological breakthrough in threat aversion.



## Reliability

VOTI's low component count (7 main components as opposed to 20+) translates to less downtime & service calls and a lower total cost of ownership. In addition, VOTI's rugged product design withstands extensive use: its high quality, quick change Line Replaceable Units (LRU) mean faster spare part delivery, and rapid servicing. In the comparative photos below, VOTI's recently enhanced hardware configuration (left) contains far fewer parts, for a cleaner and more serviceable machine than the competition (right).

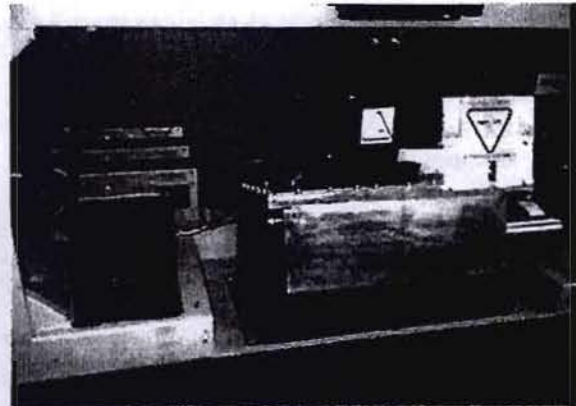
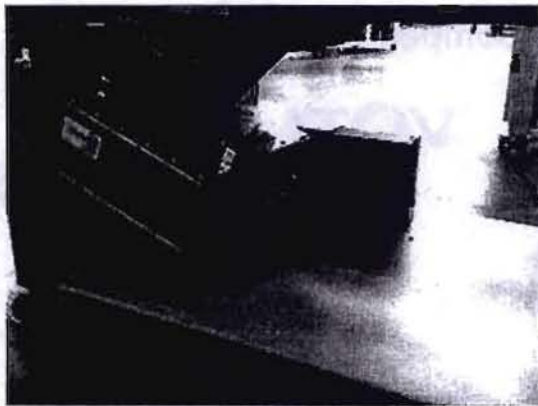

## Industry Leading Remote Troubleshooting, Diagnostics, and Repair

Technical support services are critical to the operations of the County. That is why extensive health monitoring and diagnostics are performed on every machine to prolong the maintenance cycle and reduce the need for potentially costly support calls. **Of critical importance to ensure performance for the County's fleet of X-ray scanners, many issues can be fixed at the software level with remotely administered updates and patches.** In fact, VOTI's support team – with permission from the Court – can gain access directly to the scanner when remote support is required.

## Unique Touchscreen Graphical User Interface

VOTI X-Ray scanners are equipped with an intuitive touch screen display, shown below. The touchscreen interface is more user friendly and allows for faster training. Ergonomic and intuitive, operators tend to use more of the image processing tools at their disposal than with a keyboard console. Instead of shifting eyes back and forth from the screen to the keyboard and falling into the trap of using the same functions repeatedly, operators will test the full range of functions and develop strong threat detection habits. Touchscreen operation shortens the learning curve and encourages operators to use all the tools at their disposal.



## On-Site Training

VOTI will provide a training program to ensure all functionality of the XR3D X-Ray scanner is understood and mastered by the operator. In addition, a Level 1 Maintenance training will be provided at no additional cost. A "Train-the-Trainer" program is available upon request.

## Experience In Courthouse Deployments

From the Canadian Supreme Court to the Louisiana Supreme Court, VOTI understands courthouse operations. We understand that X-rays which are out of order present a serious threat to courthouse operations: rapid servicing is critical. We recognize the reality of space constraints in courthouse entry ways: that is why we propose the short conveyor model to address this constraint, as the XR3D-60s or XR3D-50s are compact, short conveyor systems which balances a generous tunnel size with a reduced footprint and if needed, can be easily moved. Finally, we understand that a crisp, high-resolution x-ray projection is critical to uncovering threats at checkpoint entry ways.

## Timeline & Expectations

VOTI will guarantee that delivery of all X-ray scanners will be made within 12 weeks from receipt of a purchase order.

Order will be according to VOTI Ship and Charge – all freight will be pre-paid, door-to-door, and coordinated by our logistics coordinator.

Once a P.O. is received, we will build the scanners per the County's customization requests and inform the Court as they become ready for shipment. At this time, we will require that a contact from the Court be provided with whom we can coordinate the shipment.

The installation, commissioning, and training will be coordinated after this time between our Field Service Team and the Court's operations/security team. We will together find a mutually agreeable date and time slot for installation and training to ensure that all safety and training standards and protocols are met.

We will install the x-ray in a non-intrusive fashion to minimize any disturbance to the Court's operations.

## Warranty and Service Agreement

All X-Ray scanners are delivered with a full parts and labor 1-year warranty and service agreement. No additional out-of-pocket expenses will be charged to the County for any parts or service labor relating to the proper functioning of the scanners within this 1-year period.

We will also include remote service support and full technical support for the same period in which telephone assistance, including remote troubleshooting and repair, will be used to provide rapid assistance to any issue.

Understanding the need for a responsive, comprehensive service agreement to ensure that the Court can maintain full operational capacity, VOTI is proud to offer best-in-class service to ensure efficient operations. As part of our service offering, we can proudly commit to the following level of service:

- Any technical issue will be addressed within 4 business hours (either by phone or email)
- If necessary, a technician will be deployed on site for repair within 5 business days. A shorter on-site time can be discussed at the County's request.

**Annual Preventive Maintenance** refers to scheduled preventive maintenance services performed by a VOTI-certified technician in accordance with VOTI's established preventive maintenance program, including a radiation survey report and the installation of the latest software release for each scanner.



PRODUCT APPEARANCE MAY DIFFER FROM IMAGE

## Powerful 3D Perspective™ Technology

The XR3D-50s MATRIX Series, powered by BioSans MATRIX™, is an easy to operate, single source scanner that provides operators with extremely detailed, more revealing images, enhanced detection capabilities and a very low cost of ownership. The new line of MATRIX Series scanners offers best-in-class technology, achieving significant improvements in wire resolution, steel penetration and spatial resolution. MATRIX Series models are also the first XR3D scanners that can be connected through VotiINSIGHTS™, VOTI's proprietary web-based platform for centralized and remote fleet management, providing fleet managers up to the minute information about their scanner fleet's health and operational status.

With a tunnel opening of 550 mm wide by 350 mm high (21.7" x 13.8"), the XR3D-50s MATRIX Series is the ideal solution for a variety of usages such as critical infrastructures, transportation and border operations where screening of parcels, bags and mail is required.

VOTI's scanners employ innovative 3D Perspective™ technology to deliver exceptional threat detection capabilities. Through an advanced intuitive touch screen interface, operators can manipulate and enhance scanned images in a variety of ways to better pinpoint and evaluate potential threats. The overall threat detection process is enhanced by a suite of software guided tools and features, including extended and configurable threat libraries.

## Product Highlights

- 3D Perspective™ Multi Energy Imaging
- LCD Touch Screen with multi-touch zoom
- Threat Alert and Material Classification
- One-touch, Instant View Last Five Bags
- Dynamic Pseudo Density Layering
- Multilingual Operation
- Auto-Archiving
- Network-Ready
- Best-In-Class Image Quality **NEW**
- Linux based BioSans MATRIX Operating System **NEW**
- SSD with Power Loss Prevention **NEW**
- VotiINSIGHTS™ Ready **NEW**

## General Specifications

|                   |  |
|-------------------|--|
| Dimensions:       | Length (L): 1477 mm (58.1")                        |
|                   | Height (H): 1349 mm (53.1")                        |
|                   | Width (W): 766 mm (30.2")                          |
| Conveyor height:  | 762 mm (30") from floor                            |
| Tunnel size:      | 550 mm x 350 mm (21.7" by 13.8")                   |
| Max. object size: | 535 mm x 325 mm (21.1" by 12.8")                   |
| Conveyor speed:   | 0.22 m/s (44'/min.) variable speed, bi-directional |
| Conveyor load:    | 165 kg (364 lbs) max. evenly distributed weight    |
| Approx weight:    | 390 kg (860 lbs)                                   |
| System power:     | 110/240 VAC 10/5 A 50/60 Hz                        |

## X-ray Generator and Image Performance

|                     |   |
|---------------------|---|
| Generator:          | Single x-ray generator operating at 140 kV                                      |
| Cooling:            | Sealed oil bath   |
| Orientation:        | Diagonal upwards  |
| Duty cycle:         | 100%  |
| Detectors:          | Multi energy silicone photo diodes for color coding and material classification |
| Wire resolution:    | 42 AWG  |
| Steel penetration:  | 35 mm   |
| Spatial resolution: | 0.7 mm horizontal, 0.9 mm vertical  |

As measured on VOTI proprietary Test Piece

## Computer Specifications

|             |  |
|-------------|--|
| Networking: | WiFi/Ethernet  |
| Monitor:    | 24" colour LCD touch screen<br>Resolution: 1920 x 1080 |

## Operating Environment

|                        |                          |
|------------------------|--------------------------|
| Storage temperature:   | -20 to 60°C              |
| Operating temperature: | +0 to 40°C               |
| Relative humidity:     | Up to 95% non-condensing |

Certified to UL 61010-1, CAN/CSA 22.2 No. 61010-1-04, IEC 61010-1:2001  
 CE compliant: 2006/95/EC, 2006/42/EC, 2004/108/EC  
 FCC part 15  
 FDA title 21, CFR 1010.2  
 FDA title 21, CFR 1010.3  
 FDA title 21, CFR 1020.4  
 Health Canada RED Act & Safety Code 29  
 Maximum x-ray leakage: meets all applicable laws and regulations with respect to x-ray emitting devices  
 Film safety: ISO 1600/33 DIN

These specifications are subject to change without notice  
 XR3D-50s-MATRIX-EN-202010-23

© Copyright 2008-2020 VOTI Inc. - All rights reserved.

www.votidetection.com

## Dimensions

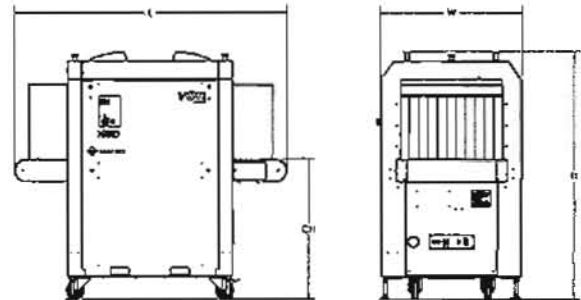

## Standard Features

- 3D Perspective™ multi energy imaging
- LCD touch screen
- Pinch to zoom functionality
- Remote technical support
- Secure USB port Auto-archiving (>200,000 sessions)
- One-touch Instant view of last 5 bags
- 25 cm shrouds
- Stainless steel conveyor covers
- Fully automatic, software-driven tube seasoning
- Network ready
- Automatic built in test & self diagnosis
- Scanned object counter
- Archive management module
- Administration module
- Restricted secure access key
- Bi-directional scanning
- VotIMAGE™
  - Image Edge Enhancement (IEE)
  - Black & white and inverse video
  - Variable contrast control
  - Digital zoom to 64x, pan and flip
  - Dynamic pseudo layering
- VotIMAT™
  - Z<sup>eff</sup> color image
  - Organic / Inorganic stripping
  - Z<sup>eff</sup> based calculation
- VotIDENS™
  - Automatic High Density Alert (HDA)
  - HD and VHD enhancement

## Applications & Options

- Extended roller tables
- Pressure sensitive mat
- Uninterruptible power supply (UPS)
- Power conditioner
- Operator console
- Monitor/console display stand
- Operator workstation
- VotIALERT™
  - Threat Detection Assistance with alerts for operator
  - Material Classification
  - Suspect Archive Tagging and Lookup
- VotINSIGHTS™
  - Web-based platform for centralized and remote management of XR3D scanners
  - Real-time information on scanner fleet health and operation status
  - Remote monitoring through secondary viewing workstation



CANADIAN TECHNOLOGY



VOTI Detection™  
 790 Bégis St, St-Laurent, Quebec H4M 2N5 Canada  
 T: +1 514.782.1566 F: +1 514.221.3948

## Pricing - XR3D-50s MATRIX

|   | DESCRIPTION  | Unit Price   | Units | Total Price \$USD |
|---|--|--------------|-------|-------------------|
| X-Ray Product/Model   | XR3D 50s 3D Perspective X-ray scanner - MATRIX<br>As per technical spec sheet: XR3D-50s-MATRIX-EN-202010-23  | \$ 19,900.00 | 1     | \$ 19,900.00      |
| Recommended Accessories   | Roller Tables: 0.5M Exit or Entry  | \$ 675.00    | 2     | OPTIONAL          |
|   | Roller Tables: 1M Exit or Entry  | \$ 790.00    | 2     | OPTIONAL          |
| Optional Software Modules and Accessories                                   | VotIALERT - Automatic operator assist threat alert and material classification   | \$ 2,500.00  | 1     | OPTIONAL          |
|   | VotITIP - Operator on-the-job training and evaluation  | \$ 2,500.00  | 1     | OPTIONAL          |
|   | Marine-Grade Dirt and Dust Proof Protective Cover  | \$ 360.00    | 1     | OPTIONAL          |
| Service Agreements + Warranty - Includes all spare parts, travel, and labor | VotIEXTEND - Premium III Plan - for XR3D-50s MATRIX - Extended to 5 years Including:<br><ul style="list-style-type: none"> <li>• All Spare Parts</li> <li>• Annual Preventative Maintenance: VotICARE - 1 included. Site visit including radiation survey, report, and preventative care.</li> <li>• Corrective Maintenance: Unlimited unscheduled visit per year for service and/or emergency repair.</li> <li>• Remote diagnostics: VotIASSIST Phone support and diagnostics included. Dedicated phone line for support.</li> <li>• Annual software updates: includes bug fixes and patches</li> </ul> | \$ 18,750.00 | 1     | \$ 18,750.00      |
| CEIA Walk-Through Metal Detector Magnetometer HIPEPLUS/PZ-0985              | HIPEPLUS/PZ Metal Detector w/antenna SS101 720mm - HI-PE PLUS Walk-Through Metal Detector, panel version, complete with dual-beam photocells transit counter, four multi zones display bars programmable as pacing lights and/or 60 localization zones with left and right indication, Met-Identity technology, Random Alarm capability, low voltage DC power, Chip-Card programming, One-Touch automatic self-installation, Bluetooth and RS-232 communication, anti-tamper on/off switch.  | \$ 3,320.00  | 1     | OPTIONAL          |
| Installation, Radiation Survey, Commissioning, and Operator Training        | For 1 X-Ray Units: VotISTART - Installation/Radiation Survey/Commissioning and VotIUNIVERSITY - Operator Training + Materials for up to 4 people & Certificate of Completion   |              |       | \$ 1,735.00       |
| Disposal  | Disposal of L3 PX 5.3 Unit - Transport to disposal site and environmental compliance. Unit must be ready for carrier to pick up (i.e. in front of building or in lobby area ready for exit)  | \$ 725.00    | 1     | \$ 725.00         |
| Shipping  | VOTI Ship & Charge to Caro, Michigan<br>Total shipping for (1) XR3D-50s<br>Delivered via roll on/roll off crate + move-in to final location<br>(Any change in the order affects shipping)  |              |       | \$ 1,150.00       |
| Total   | Applicable taxes not included  |              |       | \$ 42,260.00      |



## Preferred Customer Financing Solutions

Lessee Tuscola County  
 Equipment (1) X-Ray Scanners: Model XR3D-50s + VOTI Extend Premium III Plan  
 Equipment Cost \$42,260.00  
 Lease Options:

### 36 Month Finance Options

|                           | <u>Option #1</u> | <u>Option # 2</u> |
|---------------------------|------------------|-------------------|
| Monthly Lease Rate Factor | .02575           | .03011            |
| Monthly Rent              | \$1,088.20       | \$1,272.45        |
| Lease Type                | Buyout – 15.5%   | \$1 Buyout        |

### 60 Month Finance Options

|                           | <u>Option #3</u> | <u>Option #4</u> |
|---------------------------|------------------|------------------|
| Monthly Lease Rate Factor | .01681           | .01859           |
| Monthly Rent              | \$710.39         | \$785.61         |
| Lease Type                | Buyout – 10.1%   | \$1 Buyout       |

Fees None.

Fixed Buyout Lease *[Option #1 & Option #3]* At the end of a Fixed FMV lease you may: 1) purchase the equipment for a Fair Market Value purchase price which is listed in the above table as a % of the original equipment cost, or 2) renew the lease for 6 months at the same rental rate. If the lease renewal is chosen, at the end of the renewal period, you may: a) continue renting the equipment, b) return some or all of equipment (complete units), or c) purchase the equipment for Fair Market Value.

\$1 Buyout Lease *[Option #2 & Option #4]* At the end of a \$1 Buyout lease you will own the equipment.

Lease Rate Your rental payments are tied on the like-term swap as of January 6, 2021. When your lease starts, your monthly payments will be fixed for the duration of the lease term.

Terms and Payments The lease will begin on the day you accept the equipment. Rental payments will be due monthly (in advance).

Contact Information In order to move forward or discuss this financing solution, please contact the following First American representative:  
  
 Jay Shearer, Program Manager  
 (585) 643-3384  
[jay.shearer@favf.com](mailto:jay.shearer@favf.com)

Date January 7, 2021

*The terms and conditions of this proposal will be superseded by the final documentation for each lease schedule. This proposal is not a commitment. Lease financing will only be provided upon the satisfactory completion of due diligence and mutually acceptable documentation.*

**Accelerating growth, together.**





PRODUCT APPEARANCE MAY DIFFER FROM IMAGE

## Powerful 3D Perspective™ Technology

The XR3D-60s MATRIX Series, powered by BioSant MATRIX™, is an easy to operate, single source scanner that provides operators with extremely detailed, more revealing images, enhanced detection capabilities and a very low cost of ownership. The new line of MATRIX Series scanners offers best-in-class technology, achieving significant improvements in wire resolution, steel penetration and spatial resolution. MATRIX Series models are also the first XR3D scanners that can be connected through VotiINSIGHTS™, VOTI's proprietary web-based platform for centralized and remote fleet management, providing fleet managers up to the minute information about their scanner fleet's health and operational status.

With a tunnel opening of 615 mm wide by 425 mm high (24.2" x 16.7"), the XR3D-60s MATRIX Series is the ideal solution for a variety of usages such as critical infrastructures, transportation and border operations where screening of parcels, bags and mail is required.

VOTI's scanners employ innovative 3D Perspective™ technology to deliver exceptional threat detection capabilities. Through an advanced intuitive touch screen interface, operators can manipulate and enhance scanned images in a variety of ways to better pinpoint and evaluate potential threats. The overall threat detection process is enhanced by a suite of software guided tools and features, including extended and configurable threat libraries.

## Product Highlights

- 3D Perspective™ Multi Energy Imaging
- LCD Touch Screen with multi-touch zoom
- Threat Alert and Material Classification
- One-touch, Instant View Last Five Bags
- Dynamic Pseudo Density Layering
- Multilingual Operation
- Auto-Archiving
- Network-Ready
- Best-In-Class Image Quality **NEW**
- Linux based BioSant MATRIX Operating System **NEW**
- SSD with Power Loss Prevention **NEW**
- VotiINSIGHTS™ Ready **NEW**

## General Specifications

|                   |  |
|-------------------|--|
| Dimensions:       | Length (L): 1717 mm (67.6")                        |
|                   | Height (H): 1433 mm (56.4")                        |
|                   | Width (W): 831 mm (32.7")                          |
| Conveyor height:  | 762 mm (30") from floor                            |
| Tunnel size:      | 615 mm x 425 mm (24.2" by 16.7")                   |
| Max. object size: | 600 mm x 400 mm (23.6" by 15.7")                   |
| Conveyor speed:   | 0.22 m/s (44'/min.) variable speed, bi-directional |
| Conveyor load:    | 165 kg (364 lbs) max. evenly distributed weight    |
| Approx weight:    | 400 kg (882 lbs)                                   |
| System power:     | 120/240 VAC 10/5 A 50/60 Hz                        |

## X-ray Generator and Image Performance

|                     |   |
|---------------------|---|
| Generator:          | Single x-ray generator operating at 160 kV                                      |
| Cooling:            | Sealed oil bath   |
| Orientation:        | Diagonal upwards  |
| Duty cycle:         | 100%  |
| Detectors:          | Multi energy silicone photo diodes for color coding and material classification |
| Wire resolution:    | 44 AWG  |
| Steel penetration:  | 44 mm   |
| Spatial resolution: | 0.7 mm horizontal, 0.8 mm vertical  |

As measured on VOTI proprietary Test Piece

## Computer Specifications

|             |  |
|-------------|--|
| Networking: | WiFi/Ethernet  |
| Monitor:    | 24" colour LCD touch screen<br>Resolution: 1920 x 1080 |

## Operating Environment

|                        |                          |
|------------------------|--------------------------|
| Storage temperature:   | -20 to 60°C              |
| Operating temperature: | +0 to 40°C               |
| Relative humidity:     | Up to 95% non-condensing |

Certified to UL 61010-1, CAN/CSA 22.2 No. 61010-1-04, IEC 61010-1:2001  
 CE compliant: 2006/95/EC, 2006/42/EC, 2004/108/EC  
 FCC part 15  
 FDA title 21, CFR 1010.2  
 FDA title 21, CFR 1010.3  
 FDA title 21, CFR 1020.4  
 Health Canada RED Act & Safety Code 29  
 Maximum x-ray leakage: meets all applicable laws and regulations with respect to x-ray emitting devices  
 Film safety: ISO 1600/33 DIN

These specifications are subject to change without notice.  
 XR3D-60s-MATRIX-EN-202010-23

© Copyright 2008-2020 VOTI Inc. - All rights reserved.

www.votidetection.com

## Dimensions

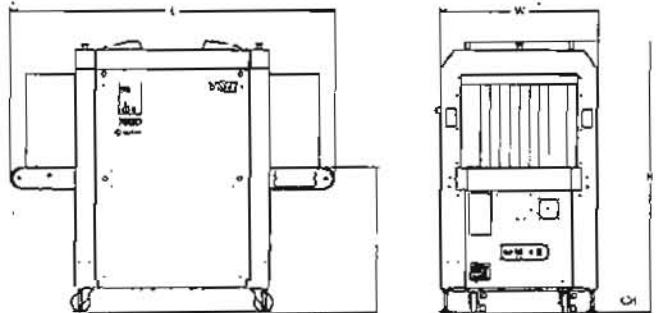

## Standard Features

- 3D Perspective™ multi energy imaging
- LCD touch screen
- Pinch to zoom functionality
- Remote technical support
- Secure USB port
- Auto-archiving (>180,000 sessions)
- One-touch Instant view of last 5 bags
- 25 cm shrouds
- Stainless steel conveyor covers
- Fully automatic, software-driven tube seasoning
- Network ready
- Automatic built in test & self diagnosis
- Scanned object counter
- Archive management module
- Administration module
- Restricted secure access key
- Bi-directional scanning
- VotiIMAGE™
  - Image Edge Enhancement (IEE)
  - Black & white and inverse video
  - Variable contrast control
  - Digital zoom to 64x, pan and flip
  - Dynamic pseudo layering
- VotiMAT™
  - Z<sup>off</sup> color image
  - Organic / inorganic stripping
  - Z<sup>off</sup> based calculation
- VotiDENS™
  - Automatic High Density Alert (HDA)
  - HD and VHD enhancement

## Applications & Options

- Extended roller tables
- Pressure sensitive mat
- Uninterruptible power supply (UPS)
- Power conditioner
- Operator console
- Monitor/console display stand
- Operator workstation
- VotiALERT™
  - Threat Detection Assistance with alerts for operator
  - Material Classification
  - Suspect Archive Tagging and Lookup
- VotiINSIGHTS™
  - Web-based platform for centralized and remote management of XR3D scanners
  - Real-time information on scanner fleet health and operation status
  - Remote monitoring through secondary viewing workstation



CANADIAN TECHNOLOGY



VOTI Detection™  
 790 Begin St, St-Laurent, Quebec H4M 2N5 Canada  
 T: +1 514.782.1566 F: +1 514.221.3948

# Pricing - XR3D-60s MATRIX

|   | DESCRIPTION   | Unit Price   | Units | Total Price \$USD |
|---|---|--------------|-------|-------------------|
| X-Ray Product/Model   | XR3D-60s 3D Perspective X-ray scanner - MATRIX<br>As per technical spec sheet: XR3D-60s-MATRIX-EN-202010-23   | \$ 20,900.00 | 1     | \$ 20,900.00      |
| Recommended Accessories   | Roller Tables: 0.5M Exit or Entry   | \$ 705.00    | 2     | OPTIONAL          |
|   | Roller Tables: 1M Exit or Entry   | \$ 825.00    | 2     | OPTIONAL          |
| Optional Software Modules and Accessories                                   | VotiALERT - Automatic operator assist threat alert and material classification  | \$ 2,500.00  | 1     | OPTIONAL          |
|   | VotiTIP - Operator on-the-job training and evaluation   | \$ 2,500.00  | 1     | OPTIONAL          |
|   | Marine-Grade Dirt and Dust Proof Protective Cover   | \$ 420.00    | 1     | OPTIONAL          |
| Service Agreements + Warranty - Includes all spare parts, travel, and labor | VotiEXTEND - Premium III Plan - for XR3D-60s MATRIX - Extended to 5 years<br>Including:<br>• All Spare Parts<br>• Annual Preventative Maintenance: VotiCARE – 1 included. Site visit including radiation survey, report, and preventative care.<br>• Corrective Maintenance: Unlimited unscheduled visit per year for service and/or emergency repair.<br>• Remote diagnostics: VotiASSIST Phone support and diagnostics included. Dedicated phone line for support.<br>• Annual software updates: includes bug fixes and patches | \$ 19,950.00 | 1     | \$ 19,950.00      |
| CEIA Walk-Through Metal Detector Magnetometer HIPEPLUS/PZ-0985              | HIPEPLUS/PZ Metal Detector w/antenna S5101 720mm - HI-PE PLUS Walk-Through Metal Detector, panel version, complete with dual-beam photo cells transit counter, four multi zones display bars programmable as pacing lights and/or 60 localization zones with left and right indication, Met-Identity technology, Random Alarm capability, low voltage DC power, Chip-Card programming, One-Touch automatic self-Installation, Bluetooth and RS-232 communication, anti-tamper on/off switch.                                      | \$ 3,320.00  | 1     | OPTIONAL          |
| Installation, Radiation Survey, Commissioning, and Operator Training        | For 1 X-Ray Units: VotiSTART - Installation/Radiation Survey/Commissioning and VotiUNIVERSITY - Operator Training + Materials for up to 4 people & Certificate of Completion  |              |       | \$ 1,735.00       |
| Disposal  | Disposal of L3 PX 5.3 Unit - Transport to disposal site and environmental compliance. Unit must be ready for carrier to pick up (i.e. in front of building or in lobby area ready for exit)   | \$ 725.00    | 1     | \$ 725.00         |
| Shipping  | VOTI Ship & Charge to Caro, Michigan<br>Total shipping for (1) XR3D-60s<br>Delivered via roll on/roll off crate + move-in to final location<br>(Any change in the order affects shipping)   |              |       | \$ 1,300.00       |
| Total   | Applicable taxes not Included   |              |       | \$ 44,610.00      |

## Preferred Customer Financing Solutions

Lessee Tuscola County  
 Equipment (1) X-Ray Scanners: Model XR3D-60s + VOTI Extend Premium III Plan  
 Equipment Cost \$44,610.00  
 Lease Options:

### 36 Month Finance Options

|                           | <u>Option #1</u> | <u>Option # 2</u> |
|---------------------------|------------------|-------------------|
| Monthly Lease Rate Factor | .02575           | .03011            |
| Monthly Rent              | \$1,148.71       | \$1,343.21        |
| Lease Type                | Buyout – 15.5%   | \$1 Buyout        |

### 60 Month Finance Options

|                           | <u>Option #3</u> | <u>Option #4</u> |
|---------------------------|------------------|------------------|
| Monthly Lease Rate Factor | .01681           | .01859           |
| Monthly Rent              | \$749.89         | \$829.30         |
| Lease Type                | Buyout – 10.1%   | \$1 Buyout       |

Fees None.

Fixed Buyout Lease [Option #1 & Option #3] At the end of a Fixed FMV lease you may: 1) purchase the equipment for a Fair Market Value purchase price which is listed in the above table as a % of the original equipment cost, or 2) renew the lease for 6 months at the same rental rate. If the lease renewal is chosen, at the end of the renewal period, you may: a) continue renting the equipment, b) return some or all of equipment (complete units), or c) purchase the equipment for Fair Market Value.

\$1 Buyout Lease [Option #2 & Option #4] At the end of a \$1 Buyout lease you will own the equipment.

Lease Rate Your rental payments are tied on the like-term swap as of January 6, 2021. When your lease starts, your monthly payments will be fixed for the duration of the lease term.

Terms and Payments The lease will begin on the day you accept the equipment. Rental payments will be due monthly (in advance).

Contact Information In order to move forward or discuss this financing solution, please contact the following First American representative:  
 Jay Shearer, Program Manager  
 (585) 643-3384  
[jay.shearer@favf.com](mailto:jay.shearer@favf.com)

Date January 7, 2021

*The terms and conditions of this proposal will be superseded by the final documentation for each lease schedule. This proposal is not a commitment. Lease financing will only be provided upon the satisfactory completion of due diligence and mutually acceptable documentation.*

## Terms of Offer:

- Subject to the VOTI's Standard Terms & Conditions of Sale (attached)
- 1-Year Warranty
- This quotation is valid for 30 days from the date of issuance.
- All prices are in USD and exclude applicable taxes.
- Payments will be as follows:
  - a. 30% Down Payment at time of order placement (P.O.)
  - b. 70% At Ready-Ship-Date
  - c. Financing options will supersede these payment terms
- Delivery will be made in accordance with VOTI SHIP AND CHARGE
- Cancellation of a Purchase Order prior to shipment will result in forfeiture of down-payment amount. Notwithstanding the above, Purchase Orders for customized Products or for models XR3D-10M, XR3D-15, XR3D-15D, XR3D-18, XR3D-18D cannot be cancelled under any circumstances.
- All payments under any contract resulting from this offer shall be made either by direct bank transfer to VOTI's account (banking info supplied at a later date).
- All system performance, dimension and weight specifications are in accordance with those specifications attached to this quotation.
- Any potential returns are subject to VOTI's Standard Return Policy.
- Scanner(s) will be delivered in their standard left-to-right configuration, unless an alternate configuration is specified within the Purchase Order.

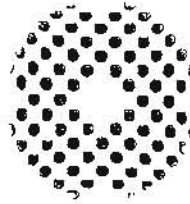

*Option C*

**MSA  
SECURITY®**

## Complete Screening Solution



**Leading the Industry in High Consequence  
Threat Protection Since 1987**

New York, NY

+1 (212) 509-1336

Arlington, VA

+1 (703) 657-4095

San Diego, CA

+1 (858) 609-1541

Hong Kong

+(852)-3690-8886

Toronto

+1 (905) 749-1486

# PROTECT PEOPLE, PROPERTY AND ASSETS

In today's heightened threat environment, perimeter security is vital for the protection of your people, property and assets. Effective X-ray screening is a critical part of a robust security plan. Any items entering your facility, whether at the entrance, mailroom, press room or loading dock, must be screened for potential threats, such as IEDs, guns, knives and other types of contraband.

MSA Security® combines sophisticated IED detection equipment with customized screener training and around-the-clock remote support for a complete screening solution delivered by:



Project Managers



X-ray Technicians



Trainers



Bomb Technicians

## TURN-KEY SOLUTION

MSA provides a turn-key complete screening solution for high-profile threat environments. Experts on our team evaluate all of your screening needs to develop a customized solution that includes equipment, training and remote support. We take the hassle and burden off your shoulders to enhance your facility security and deliver peace of mind.

### Screening Equipment

- ✓ Lease
- ✓ Purchase
- ✓ Delivery
- ✓ Installation
- ✓ Maintenance

### Screener Training

- ✓ Onsite Training
- ✓ Online Training
- ✓ Explosive Digest

### Remote Screener Support

- ✓ Master Screeners
- ✓ SmartTech®

## SCREENING EQUIPMENT

MSA provides options for the lease, purchase, delivery, installation and maintenance of today's most sophisticated, flexible and portable X-ray equipment. We offer a range of equipment options from small portable units suitable for checkpoint screening, to large units capable of screening cargo pallets or even vehicle. Our technicians recommend the right devices for your unique screening configuration and price point, and offer support for all leading X-ray manufacturers.

MSA delivers and installs the following X-ray and SmartTech® equipment and accessories:

- Thin Client PC
- Dual Monitor and Stand
- SmartTech® Software Package
- Capture Card
- MSA Test Package
- Headset with Microphone
- Keyboard/Mouse
- VGA Video Cable
- Instruction Sheet





## SCREENER TRAINING

**Online and onsite screener training** focuses on X-ray interpretation, explosives recognition, IED awareness and more. Custom programs, designed by FBI-trained bomb technicians, align with your specific screening environment and threat concerns, and are rooted in an extensive library of real-world images. Ongoing updates and informational bulletins regularly communicate trends, timely tips and images screeners are likely to face in the current landscape.

## REMOTE SCREENER SUPPORT

Experienced, well-trained screeners are a crucial component of successful detection. Yet in high-threat scenarios, a greater level of experience is required to quickly identify and assess challenging IED presentations.

MSA's exclusive SmartTech® integrates with existing X-ray equipment, enabling onsite screeners access to MSA's Emergency Operations Center in real time, 24 hours a day / 365 days a year. Our FBI-trained bomb technicians resolve suspicious images in seconds without operational disruption.

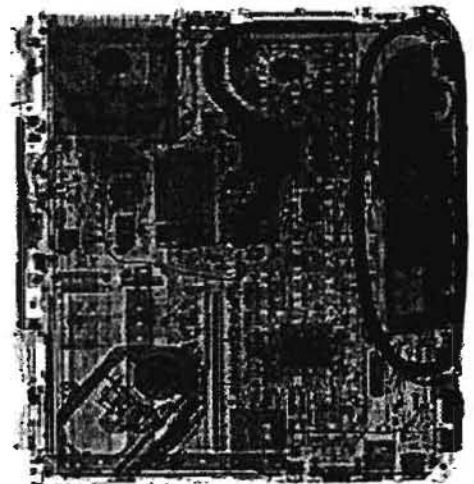

## MSA EXPLOSIVES DIGEST

MSA keeps clients up to date on emerging threats by delivering breaking news about issues that affect their perimeter security programs. Experienced bomb technicians gather and vet open source intelligence reports from around the world on a daily basis. The newsletter discusses trends in terrorism, explosive screening and detection, changes in the National Terrorism Advisory System and many other topics of interest to our clients.

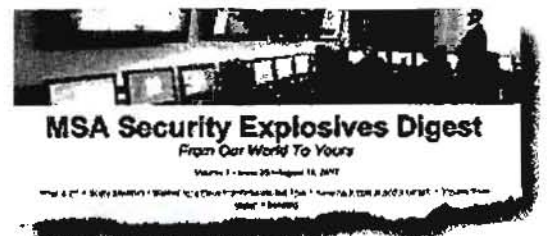



# COMPANY OVERVIEW

MSA Security® is the premier provider of **explosive detection services and high consequence threat protection**. MSA has divisions in Security and Investigations and is able to provide comprehensive security solutions tailored to our clients' unique needs. **With over 1,300 employees**, our team is comprised of active and retired members of specialized law enforcement units across the nation (e.g., SWAT, Bomb Squad, Tactical and Counterterrorism Units), as well as elite military organizations. As a result, our clients gain immediate access to individuals with extensive and unrivaled experience in the areas of:

Explosive Threats

Executive Protection

Threat Intelligence Analysis

Threat Assessment and Planning

Special Event Security

Investigations

MSA has been **Leading the Industry in High Consequence Threat Protection Since 1987**. MSA's pioneering range of best-in-class security services enables us to execute situation-specific plans that protect the flow of business and keep things moving.

# SMARTTECH<sup>®</sup> by the NUMBERS



**90** seconds  
*or less*

the average time for  
SmartTech<sup>®</sup> resolution

**90** minutes  
*or more*

the average police response  
and determination time

Over  
**180,000**

images reviewed each year

**24**

HOURS

**7**

DAYS A WEEK

**365**

DAYS A YEAR

availability to MSA bomb technicians  
for real-time analysis

More than

**900** in **42** & **42**

SmartTech<sup>®</sup> units

states

countries

Under **\$10,000**

the average annual SmartTech<sup>®</sup>  
subscription cost

**\$1.5 million**

the estimated cost associated  
with a 4-hour evacuation



# HI-SCAN™ 5030si

HEIMANN X-RAY TECHNOLOGY

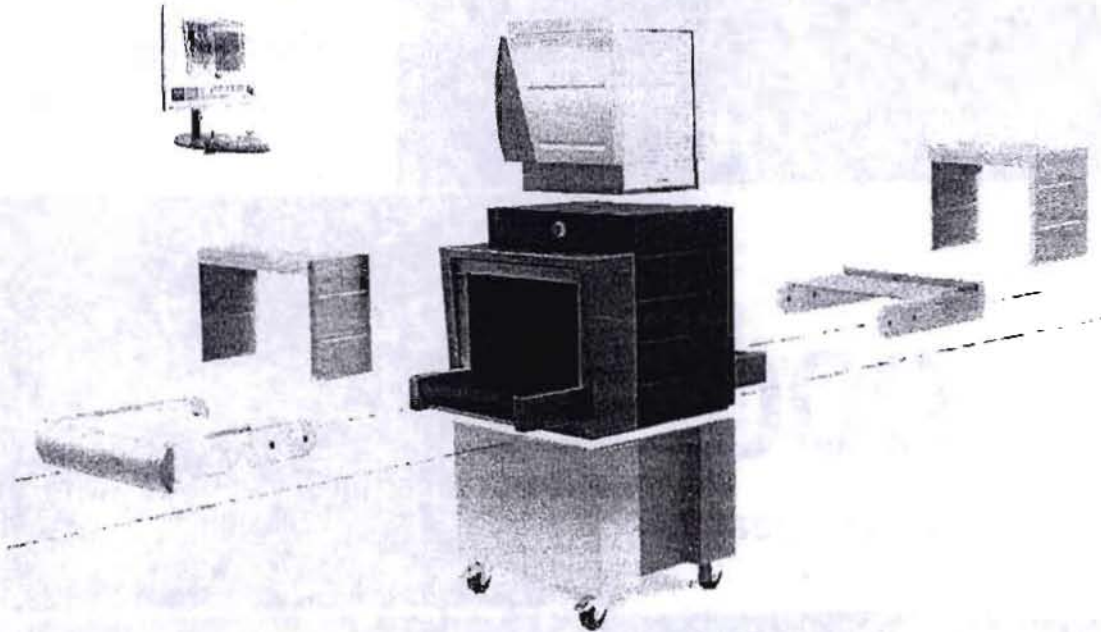

## Feature Highlights

- HI-MAT<sup>Plus</sup> advanced material classification
- Compact desktop solution for mobile and stationary applications
- New X-ray generator plus new sensor technology for high performance

## Optional

- HI-TIP: Threat Image Projection
- Xtrain: Operator training system
- IMS: Electronic image storage and archive including copy function of images in TIF or JPG format to USB storage device

HI-SCAN 5030si is the consequent advancement of HI-SCAN 5030, with more than 3000 installations worldwide an extremely successful compact X-ray inspection system.

Planned in modular design as a tabletop system, HI-SCAN 5030si is flexibly extensible and therefore is fit for different applications.

Due to state-of-the-art X-ray-, sensor- and computer-technologies this system offers functionalities, which used to be known from complex solutions for aviation security purposes only.

HI-SCAN 5030si permits configurations with operator training, TIP- and image management functionalities.

Being one of the most space-saving X-ray inspection systems available, HI-SCAN 5030si is ideal for use in mailrooms, entrance halls, correctional and judicial facilities, schools and many other security sensitive areas, where contact-free inspection of pouches, bags, letters or packages is required.

HI-SCAN 5030si - increased security by advanced technology.

### General Specifications

|   |  |
|---|--|
| Tunnel dimensions                                     | 532 [W] x 330 [H] [mm] • 21" [W] x 13" [H]                   |
| Max. object size                                      | 530 [W] x 320 [H] [mm] • 20.9" [W] x 12.6" [H]               |
| Conveyor height <sup>1)</sup>                         | approx. 190 mm [7.4"] / 782,5 mm [30.6"] with carriage       |
| Conveyor speed at mains frequency                     | approx. 0.18 / 0.22 [m/s]                                    |
| 50 Hz / 60 Hz   |  |
| Max. conveyor load (evenly distributed) <sup>2)</sup> | 60 kg [132 lbs]  |
| Resolution (wire detectability) <sup>3)</sup>         | Standard: 38 AWG [0.1 mm] • typical: 39 AWG [0.09 mm]        |
| Resolution (wire detectability) <sup>4)</sup>         | Typical: 44 AWG [0.05 mm]                                    |
| Penetration (steel) <sup>3)</sup>                     | Standard: 14 mm • typical: 16 mm                             |
| External dose rate                                    | ≤ 2 μSv/h [0.2 mrem]   |
| Film safety   | Guaranteed even for high speed films up to ISO 1600 [33 DIN] |
| Duty cycle  | 100 %, no warm-up procedure required                         |

### X-ray Generator

|                         |  |
|-------------------------|--|
| Anode voltage • cooling | 100 kV cp • hermetically sealed oil bath |
| Beam direction          | diagonal                                 |

### Image Generating System

|                            |   |
|----------------------------|---|
| X-ray converter            | L-shaped detector line, high resolution   |
| Grey levels stored         | 4096  |
| Image presentation         | B/W, color  |
| Digital video memory       | 1280 x 1024 / 24 bit  |
| Image evaluation functions | B/W, HIGH, LOW, NEG, VARI-MAT, 0°, 0S<br>electronic zoom: stepless enlargement up to 64-times |
| Monitor                    | Flat Panel LCD Monitor  |

### Additional Features

|          |  |
|----------|--|
| Features | Luggage counter, user-id number, display of operating mode, REVIEW-feature to recall previously visible image areas, zoom overview, free programmable keys |
| Options  | HI-TIP, HI-SPOT, SEN, Xport, X-ACT, IMS (Image Management System)  |

### Installation Data

|                                    |   |
|------------------------------------|---|
| X-ray leakage                      | meets all applicable laws and regulations with respect to X-ray emitting devices                          |
| CE-labelling                       | in compliance with directives 2004/108/EC, 2006/42/EC, 2006/95/EC   |
| Sound pressure level               | < 56 dB(A)  |
| Operating- / storage temperature   | 0° - 40°C / -20°C - +60°C   |
| Humidity                           | 5% - 95% (non-condensing)   |
| Power supply <sup>3)</sup>         | standard: 230 VAC or 110 VAC +10% / -15% • 50 Hz / 60 Hz ± 3 Hz   |
| Power consumption                  | approx. 0.4 kVA   |
| Protection class system / keyboard | IP 20 / IP 43   |
| Dimensions • Weight <sup>4)</sup>  | 1200 [L] x 705 [W] x 726 [H] [mm] • approx. 160 kg<br>47.3" [L] x 27.7" [W] x 28.6" [H] • approx. 352 lbs |
| Mechanical construction            | Steel construction with aluminum panels<br>standard color(s): RAL 7016 / stainless steel                  |

<sup>1)</sup> approx. values (adjustable)

<sup>2)</sup> different length of conveyor and mechanical access protection on request

<sup>3)</sup> proprietary quality management test piece: steel step wedge, CU wires, belt speed 0.2 m/s

<sup>4)</sup> proprietary quality management test piece: Pt wires, belt speed 0.2 m/s

<sup>2)</sup> different values optional

<sup>4)</sup> without control desk, keyboard, monitor(s) etc.

<sup>3)</sup> measured at ambient temperature of 20°C and nominal voltage

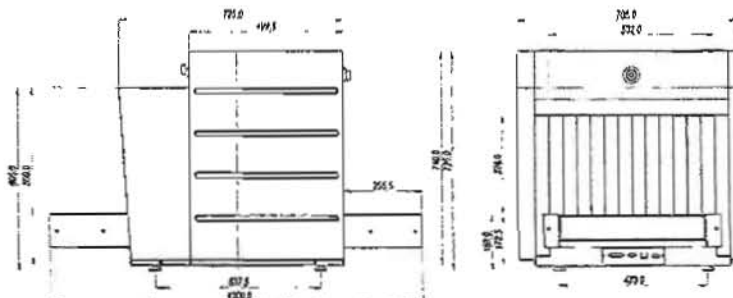

For product information, sales or service, please go to [www.smithsdetection.com/locations](http://www.smithsdetection.com/locations)

Smiths Heimann GmbH, im Herzen 4, 65205 Wiesbaden, Germany  
 Modifications reserved. 9558671 20/10/2017 © Smiths Detection Group Ltd. - In some cases, the figures contain options  
 HI-SCAN is a trademark of Smiths Detection Group Ltd.

smiths detection

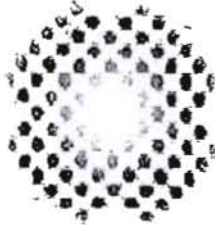

# MSA SECURITY

## Quote

No.: 71973  
Date: 1/8/2021  
Page: 2 of 4

| Project | Item  | Description  | Qty | Rate       | Total      |
|---------|---|--|-----|------------|------------|
|         | HI-SCAN 5030si : Drop Ship X-Ray : Delivery     | HI-SCAN 5030si X-Ray Delivery<br>50% due upon order (Net 30)<br>50% due upon delivery (Net 15)<br><br>*Subject to change based on location   | 1   | \$1,600.00 | \$1,600.00 |
|         | HI-SCAN 5030si : Drop Ship X-Ray : Installation | Hi-SCAN 5030si X-ray Installation<br>50% due upon order (Net 30)<br>50% due upon delivery (Net 15)   | 1   | \$1,500.00 | \$1,500.00 |
|         | HI-SCAN 5030si : On-Site Service Agreement      | -On-Site Service Coverage – 8:00 a.m. – 5:00 p.m., Monday – Friday excluding holidays<br>-Typical Response Time: within 36 hours<br>-Includes all Labor, Travel Time and Travel Expenses<br>-Includes all Replacement Parts required<br>-One Annual Preventive Maintenance check<br>-Complete operational and calibration procedure performed with a Radiation Survey<br><br>Years 2 & 3 | 2   | \$3,740.00 | \$7,480.00 |
|         | SmartTraining : Basic X-Ray Interpretation      | Basic X-Ray Interpretation Training<br>Location:<br>Tuscola County Courthouse<br>420 Court St.<br>Suite #1<br>Caro MI 48723<br>Completion Date: TBD<br><br>*Cost of Travel Outside of NYC Additional*  | 1   | \$2,500.00 | \$2,500.00 |

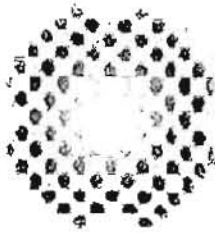

# MSA SECURITY

## Quote

No.: 71973  
Date: 1/8/2021  
Page: 3 of 4

### Additional Terms

The fees set forth on this Service Quote are valid for thirty (30) days from Quote Issue Date listed above. This Service Quote is for client budgeting purposes only until this Service Quote is fully executed by the parties.

After the Service Quote expiration date, MSA Security may modify services and or fees at its sole discretion based on industry needs

|               |                    |
|---------------|--------------------|
| Subtotal      | \$36,312.00        |
| Discount Item |                    |
| Shipping Cost |                    |
| Tax Total (%) | \$1,579.92         |
| <b>Total</b>  | <b>\$37,891.92</b> |

### Service Quote Terms of Acceptance

BY EXECUTION OF THIS SERVICE QUOTE, YOU ("CLIENT") HEREBY AGREE TO BE BOUND BY THE MSA SECURITY ("MSA") STANDARD TERMS AND CONDITIONS AS SCHEDULE A TO THIS SERVICE QUOTE AND MADE PART HEREOF (THE "AGREEMENT"). CLIENT'S AUTHORIZED SIGNATORY REPRESENTS AND WARRANTS THE FOLLOWING: (i) SHE/HE/THEY IS DULY AUTHORIZED TO BIND CLIENT TO THIS AGREEMENT; AND (ii) THE TERMS AND CONDITIONS AS SET FORTH IN THIS AGREEMENT SUPERSEDE ANY PREVIOUS QUOTATIONS, NEGOTIATIONS, PROPOSALS, COMMITMENTS (ORAL OR IN WRITING), ADVERTISEMENTS, AND UNDERSTANDINGS OF ANY NATURE WHATSOEVER.

THIS AGREEMENT AND ANY OTHER SCHEDULES INCORPORATED HEREIN CONSTITUTE THE ENTIRE AGREEMENT BETWEEN CLIENT AND MSA. THE PREPRINTED TERMS AND CONDITIONS APPEARING ON OR ATTACHED TO ANY PURCHASE ORDER ARE SOLELY FOR THE ADMINISTRATIVE CONVENIENCE OF CLIENT AND ARE NOT PART OF THIS AGREEMENT. NO ACTION, INCLUDING WITHOUT LIMITATION, THE ISSUING OF ANY CLIENT PURCHASE ORDER WILL BIND MSA WITH RESPECT TO ANY SUCH TERM AND CONDITION.

This business is licensed by the New York Department of State, Division of Licensing Services.

#### CANCELLATION POLICY

CLIENT SHALL BE RESPONSIBLE FOR ALL FEES HEREUNDER IF SERVICES ARE NOT CANCELED AT LEAST SEVEN (7) DAYS PRIOR TO SERVICES START DATE AS SET FORTH IN THIS AGREEMENT.

#### Accepted by MSA Security

Signature: \_\_\_\_\_

Date: 1/8/2021

Authorized MSA Security Signatory: \_\_\_\_\_

#### Accepted by Client

Signature: \_\_\_\_\_

Date: \_\_\_\_\_

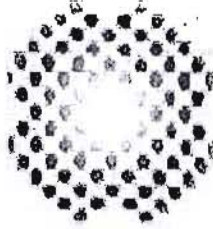

**MSA**  
**SECURITY**

## Quote

No.: 71973  
Date: 1/8/2021  
Page: 4 of 4

---

Printed Name of Authorized Client Representative: \_\_\_\_\_

Phone Number: \_\_\_\_\_

Email: \_\_\_\_\_

# HI-SCAN™ 6040ds

HEIMANN X-RAY TECHNOLOGY



## Feature Highlights

- **Compact solution for mobile and stationary applications**
- **State of the art technology with HI-MAT<sup>plus</sup> material classification**

### Optional

- **HI-TIP: Threat Image Projection**
- **Xtrain: Operator training system**
- **IMS: Electronic Image storage and archive**
- **Xport: Image export in TIF- or JPEG format incl. automatic transmission to PC via Ethernet**

HI-SCAN 6040ds has been specially developed to prevent the smuggling of dangerous objects in briefcases, handbags, rucksacks, carrier bags etc..

The system stands out with a modern design and a robust structure, optimum dimensions and a very low weight. Therefore, it is excellently suited to be used as a mobile inspection system at changing sites.

The system is filmsafe and able to penetrate up to 30 mm steel. Objects of 60 cm width and 40cm height and unlimited length can be scanned without problems.

HI-SCAN 6040ds is very easy to operate. The scanned objects can be visualized as classified material groups allowing the operator to easily and precisely identify the contents. The excellent technical equipment facilitates maximum inspection quality at minimum inspection time.

HI-SCAN 6040ds: the robust, light-weight system for security checks in entrance areas.



# Technical Data HI-SCAN 6040ds

## General Specifications

|  |  |
|--|--|
| Tunnel dimensions                                  | 620 (B) x 420 (H) [mm] • 24.4" (B) x 16.5" (H)               |
| Max. object size                                   | 615 (B) x 410 (H) [mm] • 24.2" (B) x 16.1" (H)               |
| Conveyor height <sup>1)</sup>                      | approx. 650 mm [25.6"]                                       |
| Conveyor speed at mains frequency<br>50 Hz / 60 Hz | approx. 0.2 / 0.24 [m/s]                                     |
| Max. conveyor load (evenly distributed)            | 100 kg (220.5 lbs)   |
| Resolution (wire detectability <sup>2)</sup>       | Standard: 38 AWG (0.1 mm) • typical: 39 AWG (0.09 mm)        |
| Penetration (steel) <sup>2)</sup>                  | Standard: 27 mm • typical: 30 mm                             |
| X-ray dose (typical)                               | HI-MAT: 1.6 µSv (0.16 mrem)                                  |
| Film safety  | Guaranteed even for high speed films up to ISO 1600 (33 DIN) |
| Duty cycle   | 100 %, no warm-up procedure required                         |

## X-ray Generator

|                         |  |
|-------------------------|--|
| Anode voltage • cooling | 140 kV cp • hermetically sealed oil bath |
| Beam direction          | diagonal                                 |

## Image Generating System

|                            |  |
|----------------------------|--|
| X-ray converter            | L-shaped detector line, high resolution  |
| Grey levels stored         | 4096   |
| Image presentation         | B/W, color   |
| Digital video memory       | 1280 x 1024 / 24 bit   |
| Image evaluation functions | B/W, HIGH, LOW, NEG; incl. Option HI-MAT, additionally VARI-MAT, O <sup>3</sup> , OS<br>electronic zoom: stepless enlargement up to 16-times |
| Monitor                    | Flat Panel LCD Monitor   |

## Additional Features

|          |  |
|----------|--|
| Features | Luggage counter, user-id number, display of operating mode, REVIEW-feature to recall previously visible image areas, zoom overview, free programmable keys |
| Options  | HI-TIP, HI-SPOT, SEN, Xport, IMS (Image Management System)   |

## Installation Data

|                                   |  |
|-----------------------------------|--|
| X-ray leakage                     | meets all applicable laws and regulations with respect to X-ray emitting devices   |
| CE-labelling                      | in compliance with directives 2004/108/EC, 2006/42/EC, 2006/95/EC  |
| Sound pressure level              | < 56 dB(A)   |
| Operating- / storage temperature  | 0° - 40°C / -20°C - +60°C  |
| Humidity                          | 10% - 90% (non-condensing)   |
| Power supply <sup>4)</sup>        | standard: 230 VAC or 110 VAC +10% / -15% • 50 Hz / 60 Hz ± 3 Hz  |
| Power consumption                 | approx. 0.5 kVA  |
| Protection class system           | IP 20  |
| Dimensions • Weight <sup>5)</sup> | 1730 (L) <sup>2)</sup> x 797 (B) x 1180 (H) [mm] • approx. 340 kg<br>68" (L) <sup>2)</sup> x 31.4" (B) x 46.5" (H) • approx. 748 lbs |
| Mechanical construction           | Steel construction with aluminum panels<br>standard color(s): RAL 7016 / stainless steel   |

<sup>1)</sup> approx. values (adjustable)

<sup>2)</sup> different length of conveyor and mechanical access protection on request

<sup>3)</sup> proprietary quality management test piece: steel step wedge, CU wires, belt speed 0.2 m/s

<sup>4)</sup> different values optional

<sup>5)</sup> without control desk, keyboard, monitor(s) etc.

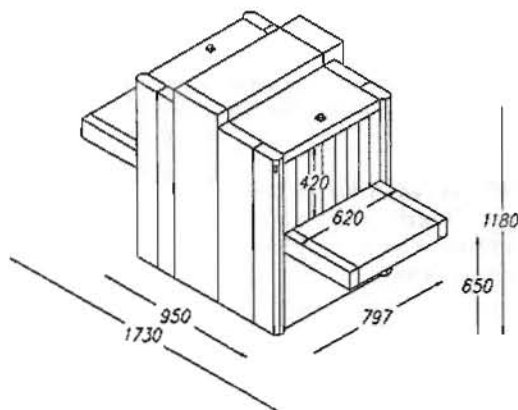

For product information, sales or service, please go to [www.smithsdetection.com/locations](http://www.smithsdetection.com/locations)

Smiths Helmann GmbH, Im Herzen 4, 65205 Wiesbaden, Germany  
Modifications reserved. 95589206 22/11/2012 © Smiths Detection Group Ltd. - In some cases, the figures contain options  
HI-SCAN is a trademark of Smiths Detection Group Ltd.



smiths detection

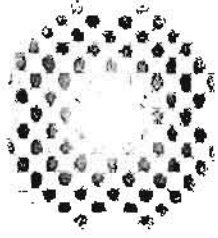

# MSA SECURITY

## Quote

No.: 71973  
Date: 1/8/2021  
Page: 1 of 4

### Client Name and Address

Tuscola County Courthouse  
420 Court St.  
Suite #1  
Caro MI 48723

### Bill To Address

Steve Anderson  
Tuscola County Courthouse  
tcemanderson@tuscolacounty.org

### Quote Overview

Hi-Scan 5030si X-Ray Purchase : Caro, MI : 2021

### Terms

|                     |                         |                      |
|---------------------|-------------------------|----------------------|
| <b>PO Required?</b> | <b>Quote Expiration</b> | <b>Payment Terms</b> |
|                     | 2/7/2021                | Net 30               |

### Point of Contact

**MSA Sales Rep:** 100933 Phillip P Marino  
**Email:** [PMarino@msasecurity.net](mailto:PMarino@msasecurity.net)  
**Phone:**

| Project | Item                              | Description   | Qty | Rate        | Total       |
|---------|-----------------------------------|---|-----|-------------|-------------|
|         | HI-SCAN 5030si : Drop Ship X-Ray  | HI-SCAN 5030si with one year manufacturer warranty<br>50% due upon order (Net 30)<br>50% due upon delivery (Net 15) | 1   | \$21,082.00 | \$21,082.00 |
|         | HI-SCAN 5030si : .5m Roller Table | HI-SCAN 5030si .5m roller table<br>50% due upon order (Net 30)<br>50% due upon delivery (Net 15)                    | 1   | \$1,000.00  | \$1,000.00  |
|         | HI-SCAN 5030si : 1m Roller Table  | HI-SCAN 5030si 1m roller table<br>50% due upon order (Net 30)<br>50% due upon delivery (Net 15)                     | 1   | \$1,150.00  | \$1,150.00  |



# MSA SECURITY

## Quote

No.: 71974  
Date: 1/8/2021  
Page: 1 of 3

### Client Name and Address

Tuscola County Courthouse  
420 Court St.  
Suite #1  
Caro MI 48723

### Bill To Address

Steve Anderson  
Tuscola County Courthouse  
tcemanderson@tuscolacounty.org

### Quote Overview

Hi-Scan 6040ds X-Ray Purchase : Caro, MI : 2021

### Terms

|                     |                         |                      |
|---------------------|-------------------------|----------------------|
| <b>PO Required?</b> | <b>Quote Expiration</b> | <b>Payment Terms</b> |
|                     | 2/7/2021                | Net 30               |

### Point of Contact

**MSA Sales Rep:** 100933 Phillip P Marino  
**Email:** [PMarino@msasecurity.net](mailto:PMarino@msasecurity.net)  
**Phone:**

| Project                               | Item  | Description   | Qty | Rate        | Total       |
|---------------------------------------|---|---|-----|-------------|-------------|
|                                       | HI-SCAN 6040ds : Drop Ship X-Ray            | HI-SCAN 6040ds with one year manufacturer warranty<br>50% due upon order (Net 30)<br>50% due upon delivery (Net 15) | 1   | \$29,356.00 | \$29,356.00 |
|                                       | HI-SCAN 6040ds : .5m Roller Table           | HI-SCAN 6040DS .5m roller table<br>50% due upon order (Net 30)<br>50% due upon delivery (Net 15)                    | 1   | \$1,050.00  | \$1,050.00  |
|                                       | HI-SCAN 6040ds : 1m Roller Table            | HI-SCAN 6040ds 1m Roller Table<br>50% due upon order (Net 30)<br>50% due upon delivery (Net 15)                     | 1   | \$1,350.00  | \$1,350.00  |
|                                       | HI-SCAN 6040ds : Drop Ship X-Ray : Delivery | HI-SCAN 6040ds X-Ray Delivery<br>50% due upon order (Net 30)<br>50% due upon delivery (Net 15)                      | 1   | \$1,600.00  | \$1,600.00  |
| * Subject to change based on location |   |   |     |             |             |

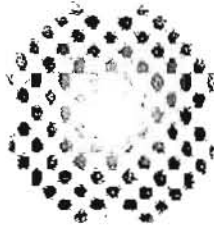

# MSA SECURITY

## Quote

No.: 71974  
Date: 1/8/2021  
Page: 2 of 3

| Project | Item  | Description  | Qty | Rate       | Total       |
|---------|---|--|-----|------------|-------------|
|         | HI-SCAN 6040ds : Drop Ship X-Ray : Installation | HI-SCAN 6040ds X-ray Installation<br>50% due upon order (Net 30)<br>50% due upon delivery (Net 15)   | 1   | \$1,500.00 | \$1,500.00  |
|         | HI-SCAN 6040ds : On-Site Service Agreement      | -On-Site Service Coverage – 8:00 a.m. – 5:00 p.m., Monday – Friday excluding holidays<br>-Typical Response Time: within 36 hours<br>-Includes all Labor, Travel Time and Travel Expenses<br>-Includes all Replacement Parts required<br>-One Annual Preventive Maintenance check<br>-Complete operational and calibration procedure performed with a Radiation Survey<br><br>Years 2 & 3 | 2   | \$5,500.00 | \$11,000.00 |
|         | SmartTraining : Basic X-Ray Interpretation      | Basic X-Ray Interpretation Training<br>Location:<br>Tuscola County Courthouse<br>420 Court St.<br>Suite #1<br>Caro MI 48723<br>Completion Date: TBD<br><br>*Cost of Travel Outside of NYC Additional*  | 1   | \$2,500.00 | \$2,500.00  |

### Additional Terms

The fees set forth on this Service Quote are valid for thirty (30) days from Quote Issue Date listed above. This Service Quote is for client budgeting purposes only until this Service Quote is fully executed by the parties.

After the Service Quote expiration date, MSA Security may modify services and or fees at its sole discretion based on industry needs

|                      |             |
|----------------------|-------------|
| <b>Subtotal</b>      | \$48,356.00 |
| <b>Discount Item</b> |             |
| <b>Shipping Cost</b> |             |
| <b>Tax Total (%)</b> | \$2,091.36  |
| <b>Total</b>         | \$50,447.36 |

### Service Quote Terms of Acceptance

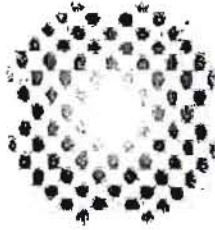

# MSA SECURITY

## Quote

No.: 71974  
Date: 1/8/2021  
Page: 3 of 3

BY EXECUTION OF THIS SERVICE QUOTE, YOU ("CLIENT") HEREBY AGREE TO BE BOUND BY THE MSA SECURITY ("MSA") STANDARD TERMS AND CONDITIONS AS SCHEDULE A TO THIS SERVICE QUOTE AND MADE PART HEREOF (THE "AGREEMENT"). CLIENT'S AUTHORIZED SIGNATORY REPRESENTS AND WARRANTS THE FOLLOWING: (i) SHE/HE/THEY IS DULY AUTHORIZED TO BIND CLIENT TO THIS AGREEMENT; AND (ii) THE TERMS AND CONDITIONS AS SET FORTH IN THIS AGREEMENT SUPERSEDE ANY PREVIOUS QUOTATIONS, NEGOTIATIONS, PROPOSALS, COMMITMENTS (ORAL OR IN WRITING), ADVERTISEMENTS, AND UNDERSTANDINGS OF ANY NATURE WHATSOEVER.

THIS AGREEMENT AND ANY OTHER SCHEDULES INCORPORATED HEREIN CONSTITUTE THE ENTIRE AGREEMENT BETWEEN CLIENT AND MSA. THE PREPRINTED TERMS AND CONDITIONS APPEARING ON OR ATTACHED TO ANY PURCHASE ORDER ARE SOLELY FOR THE ADMINISTRATIVE CONVENIENCE OF CLIENT AND ARE NOT PART OF THIS AGREEMENT. NO ACTION, INCLUDING WITHOUT LIMITATION, THE ISSUING OF ANY CLIENT PURCHASE ORDER WILL BIND MSA WITH RESPECT TO ANY SUCH TERM AND CONDITION.

This business is licensed by the New York Department of State, Division of Licensing Services.

### CANCELLATION POLICY

CLIENT SHALL BE RESPONSIBLE FOR ALL FEES HEREUNDER IF SERVICES ARE NOT CANCELED AT LEAST SEVEN (7) DAYS PRIOR TO SERVICES START DATE AS SET FORTH IN THIS AGREEMENT.

---

### Accepted by MSA Security

Signature: \_\_\_\_\_

Date: 1/8/2021

Authorized MSA Security Signatory: \_\_\_\_\_

### Accepted by Client

Signature: \_\_\_\_\_

Date: \_\_\_\_\_

Printed Name of Authorized Client Representative: \_\_\_\_\_

Phone Number: \_\_\_\_\_

Email: \_\_\_\_\_

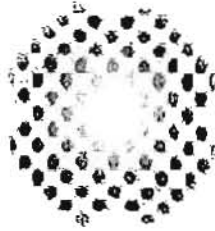

# MSA SECURITY

## Quote

No.: 71979  
Date: 1/12/2021  
Page: 1 of 2

### Client Name and Address

Tuscola County Courthouse  
420 Court St.  
Suite #1  
Caro MI 48723

### Bill To Address

Steve Anderson  
Tuscola County Courthouse  
tcemanderson@tuscolacounty.org

### Quote Overview

Online Basic X-Ray Training : Caro, MI : 2021

### Terms

|                     |                         |                      |
|---------------------|-------------------------|----------------------|
| <b>PO Required?</b> | <b>Quote Expiration</b> | <b>Payment Terms</b> |
|                     | 2/11/2021               | Net 30               |

### Point of Contact

**MSA Sales Rep:** 100933 Philip P Marino  
**Email:** [PMarino@msasecurity.net](mailto:PMarino@msasecurity.net)  
**Phone:**

| Project | Item   | Description                                | Qty | Rate     | Total      |
|---------|--|--|-----|----------|------------|
|         | SmartTraining : Basic X-Ray Interpretation E-Version | Online Basic X-Ray Interpretation Training | 6   | \$250.00 | \$1,500.00 |

Completion Date: Within one year of order.

Base Price: \$250 per participant

### Additional Terms

The fees set forth on this Service Quote are valid for thirty (30) days from Quote Issue Date listed above. This Service Quote is for client budgeting purposes only until this Service Quote is fully executed by the parties.

After the Service Quote expiration date, MSA Security may modify services and or fees at its sole discretion based on industry needs

|                      |            |
|----------------------|------------|
| <b>Subtotal</b>      | \$1,500.00 |
| <b>Discount Item</b> |            |
| <b>Shipping Cost</b> |            |
| <b>Tax Total (%)</b> | \$0.00     |
| <b>Total</b>         | \$1,500.00 |

### Service Quote Terms of Acceptance

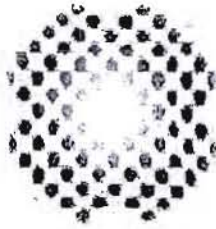

**MSA  
SECURITY**

**Quote**

No.: 71979  
Date: 1/12/2021  
Page: 2 of 2

BY EXECUTION OF THIS SERVICE QUOTE, YOU ("CLIENT") HEREBY AGREE TO BE BOUND BY THE MSA SECURITY ("MSA") STANDARD TERMS AND CONDITIONS AS SCHEDULE A TO THIS SERVICE QUOTE AND MADE PART HEREOF (THE "AGREEMENT"). CLIENT'S AUTHORIZED SIGNATORY REPRESENTS AND WARRANTS THE FOLLOWING: (i) SHE/HE/THEY IS DULY AUTHORIZED TO BIND CLIENT TO THIS AGREEMENT; AND (ii) THE TERMS AND CONDITIONS AS SET FORTH IN THIS AGREEMENT SUPERSEDE ANY PREVIOUS QUOTATIONS, NEGOTIATIONS, PROPOSALS, COMMITMENTS (ORAL OR IN WRITING), ADVERTISEMENTS, AND UNDERSTANDINGS OF ANY NATURE WHATSOEVER.

THIS AGREEMENT AND ANY OTHER SCHEDULES INCORPORATED HEREIN CONSTITUTE THE ENTIRE AGREEMENT BETWEEN CLIENT AND MSA. THE PREPRINTED TERMS AND CONDITIONS APPEARING ON OR ATTACHED TO ANY PURCHASE ORDER ARE SOLELY FOR THE ADMINISTRATIVE CONVENIENCE OF CLIENT AND ARE NOT PART OF THIS AGREEMENT. NO ACTION, INCLUDING WITHOUT LIMITATION, THE ISSUING OF ANY CLIENT PURCHASE ORDER WILL BIND MSA WITH RESPECT TO ANY SUCH TERM AND CONDITION.

This business is licensed by the New York Department of State, Division of Licensing Services.

**CANCELLATION POLICY**

CLIENT SHALL BE RESPONSIBLE FOR ALL FEES HEREUNDER IF SERVICES ARE NOT CANCELED AT LEAST SEVEN (7) DAYS PRIOR TO SERVICES START DATE AS SET FORTH IN THIS AGREEMENT.

**Accepted by MSA Security**

Signature: \_\_\_\_\_

Date: 1/12/2021

Authorized MSA Security Signatory: \_\_\_\_\_

**Accepted by Client**

Signature: \_\_\_\_\_

Date: \_\_\_\_\_

Printed Name of Authorized Client Representative: \_\_\_\_\_

Phone Number: \_\_\_\_\_

Email: \_\_\_\_\_



**POINT SECURITY INC.**  
FIRST IN SECURITY SCREENING

1-800-476-1607

Option D

# HI-SCAN 5030si

Heimann X-Ray Inspection System

## Feature Highlights

- Compact desktop solution for mobile and stationary applications
- New X-ray generator plus new sensor technology for high performance
- Tunnel opening of 50 x 30 cm
- Typical penetration 16 mm of steel, wire resolution up to AWG 39

## Optional

- HI-TIP: Threat Image Projection
- Xtrain: Operator training system
- IMS: Electronic image storage and archive including copy function of images in TIF or JPG format to USB storage device



The **HI-SCAN 5030si** X-ray inspection system is part of a compact range that has achieved more than 3,000 installations worldwide. Planned in modular design as a tabletop system, **HI-SCAN 5030si** offers considerable flexibility, making it suitable for several different applications. Due to its small foot print and robust casters it is easily wheeled even through narrow spaces and over rugged terrain to any place where personal belongings and other items need to be screened.

**HI-SCAN 5030si** is ideal for use in mailrooms, entrance halls, correctional and judicial facilities, schools and many other security sensitive areas, where contact-free inspection of pouches, bags, letters or packages is required.



# Technical Information HI-SCAN 5030si

## General Specifications

- Tunnel Dimensions 532 (W) x 330 (H) [mm] • 21" (W) x 13" (H)
- Max. Object Size 530 (W) x 320 (H) [mm] • 20.9" (W) x 12.6" (H)
- Conveyor Height <sup>1)</sup> approx. 190 mm (7.4") / 782.5 mm (30.6") with carriage
- Conveyor Speed at Mains Frequency 50 Hz / 60 Hz approx. 0.18 / 0.22 [m/s]
- Max. Conveyor Load (evenly distributed) 60 kg (132 lbs)
- Resolution (wire detectability) <sup>3)/4)</sup> Standard: 38 AWG (0.1 mm) • typical: 39 AWG (0.09 mm) / 44 AWG (0.05mm)
- Penetration (steel) <sup>3)</sup> Standard: 14 mm • typical: 16 mm
- X-ray Dose (typical) HI-MAT: 0.8 µSv (0.08 mrem)
- Film Safety Guaranteed even for high speed films up to ISO 1600 (33 DIN)
- Duty Cycle 100%, no warm-up procedure required

## X-ray Generator

- Anode Voltage • Cooling 100 kV cp • hermetically sealed oil bath
- Beam Direction diagonal

## Image Generating System

- X-ray Converter L-shaped detector line, high resolution
- Grey Levels Stored 4096
- Image Presentation B/W, color
- Digital Video Memory 1280 x 1024 / 24 bit
- Image Evaluation Functions B/W, HIGH, LOW, NEG, VARI-MAT, O<sup>2</sup>, OS

16-times

- Monitor Flat Panel LCD Monitor

## Additional Features

- Features Luggage counter, user-id number, display of operating mode, Review-feature to recall previously visible image areas, zoom overview, free programmable keys
- Options HI-TIP, HI-SPOT, SEN, Xport, X-ACT, IMS (Image Management System)

## Installation Data

- X-ray Leakage meets all applicable laws & regulations w/ respect to X-ray emitting devices
- CE-labelling in compliance with directives 2004/108/EC, 2006/42/EC, 2006/95/EC
- Sound Pressure Level < 56 dB(A)
- Operating / Storage Temperature 32°F - 104°F / -4°F - 140°F (0° - 40°C / -20°C - +60°C)
- Humidity 10% - 90% (non-condensing)
- Power Supply <sup>5)</sup> standard: 230 VAC or 110 VAC + 10% / -15% • 50 Hz / 60 Hz ± 3 Hz
- Power Consumption approx. 0.4 kVA
- Protection Class System IP 20 / IP43
- Dimensions • Weight <sup>6)</sup> 1200 (L)<sup>2)</sup> x 705 (B) x 726 (H) [mm] • approx. 160 kg  
47.3" (L)<sup>2)</sup> x 27.7" (B) x 28.6" (H) • approx. 352 lbs
- Mechanical Construction Steel construction with aluminum panels  
Standard color(s): RAL 7016 / stainless steel



<sup>1)</sup> approx. values (adjustable)

<sup>2)</sup> Different length of conveyor and mechanical access protection on request

<sup>3)</sup> Proprietary quality management test piece: steel step wedge, CU wires, belt speed 0.2 m/s

<sup>4)</sup> proprietary quality management test piece: Pt wires, belt speed 0.2 m/s

<sup>5)</sup> different values optional

<sup>6)</sup> without control desk, keyboard, monitor(s) etc.



**POINT SECURITY INC.**  
FIRST IN SECURITY SCREENING

[www.pointsecurityinc.com](http://www.pointsecurityinc.com)

Point Security, Inc.  
5815 NC Hwy 8 South  
Lexington, NC 27292  
1-800-476-1607



# Point Security, Inc.

5815 NC Hwy. 8 South  
 Lexington, NC 27292  
 (336) 357-3417

## Estimate

| Date      | Estimate # |
|-----------|------------|
| 1/18/2021 | 21-1066    |

| Customer:                          |
|------------------------------------|
| Tuscola Co., MI<br>Steven Anderson |

| Bid Number           | Job   | Terms    | Decision Date | Sales Rep  | FOB         |
|----------------------|---|----------|---------------|------------|-------------|
|                      |   | Net 30   | 2/17/2021     | Evan       | Destination |
| Item                 | Description   | Quantity | Amount        | Total      |             |
| 5030si               | POC: Steve Anderson<br>email: tcemanderson@tuscolacounty.org<br>Cell: 989-450-0147<br>Office: 989-673-5181<br><br>5030si, X-Ray Inspection System<br>Smiths Detection<br>Cart<br>19"LCD<br>12 Month Standard Warranty<br>Hi-SPOT- Auto Dense Area Detection<br>Hi-TRAX- Image Enhancement Functions | 1.00     | 21,900.00     | 21,900.00T |             |
| HEI-.5M-5030si-Entry | Table, .5M/20" Entry Roller - 5030si  | 1.00     | 850.00        | 850.00T    |             |
| HEI-.5M-5030si-Exit  | Table, .5M/20" Exit Roller - 5030si   | 1.00     | 850.00        | 850.00T    |             |
| HEI-Adv. HI-TraX     | Advanced Software Package,<br>HI-TIP-Plus - Treat Image Projection<br>OTS Xtrain - Operator Training System<br>IMS - Image Management System<br>Opti-ZOOM - Magnification Optimization<br>HDA - High Density Alert  | 1.00     | 2,500.00      | 2,500.00T  |             |
| Installation X-Ray   | Installation of X-Ray Inspection System<br>-Assembly, Testing and Final Commissioning<br>-Radiation Safety Inspection<br>-2-hour Operator Orientation by FSE  | 1.00     | 1,250.00      | 1,250.00   |             |

Thank you for considering Point Security. **Total**



# Point Security, Inc.

5815 NC Hwy. 8 South  
 Lexington, NC 27292  
 (336) 357-3417

## Estimate

| Date      | Estimate # |
|-----------|------------|
| 1/18/2021 | 21-1066    |

| Customer:                          |
|------------------------------------|
| Tuscola Co., MI<br>Steven Anderson |

| Bid Number                                | Job   | Terms    | Decision Date | Sales Rep    | FOB         |
|---|---|----------|---------------|--------------|-------------|
|   |   | Net 30   | 2/17/2021     | Evan         | Destination |
| Item                                      | Description   | Quantity | Amount        | Total        |             |
| Freight-Billed To Client                  | Freight, Shipping and Handling  | 1.00     | 900.00        | 900.00T      |             |
| PHEI-Warranty X-ray                       | On-Site Extended Warranty<br>w/ Annual PMI and Radiation Leak Survey<br>On-Site Coverage, M-F, 08:30-17:00<br>All Labor, Travel, Expenses<br>All replacement parts required   |          |               | 0.00T        |             |
| PHEI-Warranty4                            | On Site Ext. Warranty, Four Years (5 Total)   | 1.00     | 11,760.00     | 11,760.00T   |             |
|   | Are you sales tax exempt? Yes or No<br>If yes, please provide resale certificate or tax exempt number.<br>Sales Tax and Duties, if required, are not included in this pricing. Written documentation is required in order to waive sales tax. |          |               | 0.00         |             |
| Thank you for considering Point Security. |   |          |               | <b>Total</b> | \$40,010.00 |



# Point Security, Inc.

5815 NC Hwy. 8 South  
 Lexington, NC 27292  
 (336) 357-3417

## Estimate

| Date     | Estimate # |
|----------|------------|
| 1/5/2021 | 20-3645    |

| Customer:                          |
|------------------------------------|
| Tuscola Co., MI<br>Steven Anderson |

| Bid Number | Job | Terms  | Decision Date | Sales Rep | FOB         |
|------------|-----|--------|---------------|-----------|-------------|
|            |     | Net 30 | 2/4/2021      | Evan      | Destination |

| Item             | Description   | Quantity | Amount | Total     |
|------------------|---|----------|--------|-----------|
| Rental-XRSM Long | <p>- Quote below would be for Long-Term Lease (5 year).<br/>           - Includes installation, freight and all repairs and maintenance service during the lease and the removal of units at end of lease.<br/>           - Negligent damage is not covered under the repairs and maintenance service.<br/>           - X-ray system will be fully loaded with software options and roller table conveyor beds (entry &amp; exit per need). 1/2-meter or 1-meter roller table options available.<br/>           - Termination of rental prior to 5-years will incur prorated fees for installation and freight costs.</p> <p>The cost on the estimate represents 1 year<br/>           You have the choice of being invoiced monthly / quarterly / or annually</p> <p>Rental of Small Parcel X-Ray, Long Term<br/>           Smith Detection- 5030si / 6040ds<br/>           Routine Maintenance/Repairs Included<br/>           Annual Agreement<br/>           \$750.00 per month</p> <p><b>**ROLLER TABLE OPTIONS**</b><br/>           Table, .5M/20" Entry or Exit Roller<br/>           Table, 1M/40" Entry or Exit Roller</p> | 12.00    | 750.00 | 9,000.00T |

Thank you for considering Point Security.

|              |
|--------------|
| <b>Total</b> |
|--------------|



# Point Security, Inc.

5815 NC Hwy. 8 South  
 Lexington, NC 27292  
 (336) 357-3417

## Estimate

| Date     | Estimate # |
|----------|------------|
| 1/5/2021 | 20-3645    |

| Customer:                          |
|------------------------------------|
| Tuscola Co., MI<br>Steven Anderson |

| Bid Number                                | Job  | Terms    | Decision Date | Sales Rep    | FOB         |
|---|--|----------|---------------|--------------|-------------|
|   |  | Net 30   | 2/4/2021      | Evan         | Destination |
| Item                                      | Description  | Quantity | Amount        | Total        |             |
| Installation X-Ray                        | Installation of X-Ray Inspection Systems<br>-Assembly, Testing and Final Commissioning<br>-Radiation Safety Inspection<br>-2-hour Operator Orientation by FSE  | 1.00     | 0.00          | 0.00         |             |
| Freight-Billed To Client                  | Freight, Shipping and Handling<br>Freight IN   | 1.00     | 0.00          | 0.00T        |             |
| Freight-Billed To Client                  | Freight, Shipping and Handling<br>Freight OUT  | 1.00     | 0.00          | 0.00T        |             |
| Disposal                                  | Disposal of Discarded Equipment<br>1 - L3 5.3<br>Are you sales tax exempt? Yes or No<br>If yes, please provide resale certificate or tax exempt number.<br>Sales Tax and Duties, if required, are not included in this pricing. Written documentation is required in order to waive sales tax. | 1.00     | 0.00          | 0.00         | 0.00        |
| Thank you for considering Point Security. |  |          |               | <b>Total</b> | \$9,000.00  |



**POINT SECURITY INC.**  
FIRST IN SECURITY SCREENING

1-800-476-1607

# HI-SCAN 6040ds

Heimann X-Ray Inspection System

## Feature Highlights

- Compact solution for mobile and stationary applications
- State-of-the-Art technology with HI-MAT<sup>Plus</sup> material classification
- Tunnel opening of 60 x 40 cm
- Typical penetration 30 mm of steel, wire resolution up to AWG 39

## Optional

- HI-TIP: Threat Image Projection
- Xtrain: Operator training system
- IMS: Electronic image storage and archive
- Xport: Image export in TIF- or JPEG format incl. automatic transmission to PC via Ethernet

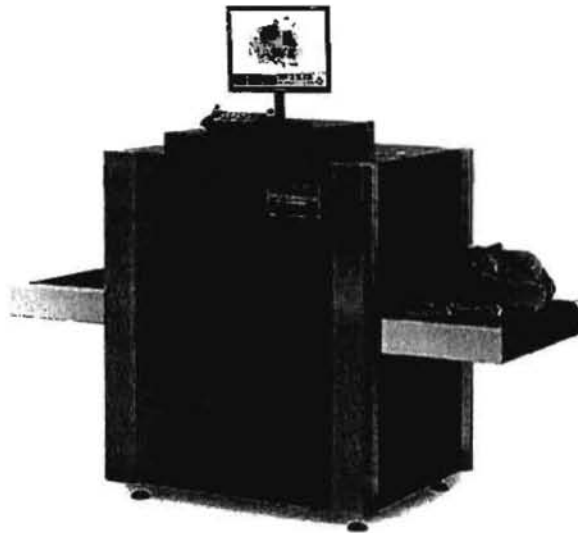

**HI-SCAN 6040ds** has been specially developed to prevent the smuggling of dangerous objects in briefcases, handbags, rucksacks, carrier bags etc.

It has a modern design and a robust structure, optimum dimensions and a very low weight and is ideally suited for use as a mobile inspection system.

The system is able to penetrate steel up to 30 mm. Objects of 60 cm width and 40cm height and unlimited length can be scanned routinely. **HI-SCAN 6040ds** is very easy to operate. The scanned objects can be visualized as classified material groups allowing the operator to identify the contents easily and precisely.

## Technical Information HI-SCAN 6040ds

### General Specifications

- Tunnel Dimensions 620 (B) x 420 (H) [mm] • 24.4" (B) x 16.5" (H)
- Max. Object Size 615 (B) x 410 (H) [mm] • 24.2" (B) x 16.1" (H)
- Conveyor Height <sup>1)</sup> approx. 650 mm (25.6")
- Conveyor Speed at Mains Frequency 50 Hz / 60 Hz approx. 0.2 / 0.24 [m/s]
- Max. Conveyor Load (evenly distributed) 100 kg (220.5 lbs)
- Resolution (wire detectability) <sup>3)</sup> Standard: 38 AWG (0.1 mm) • typical: 39 AWG (0.09 mm)
- Penetration (steel) <sup>3)</sup> Standard: 27 mm • typical: 30 mm
- X-ray Dose (typical) HI-MAT: 1.6  $\mu$ Sv (0.16 mrem)
- Film Safety Guaranteed even for high speed films up to ISO 1600 (33 DIN)
- Duty Cycle 100%, no warm-up procedure required

### X-ray Generator

- Anode Voltage • Cooling 140 kV cp • hermetically sealed oil bath
- Beam Direction diagonal

### Image Generating System

- X-ray Converter L-shaped detector line, high resolution
- Grey Levels Stored 4096
- Image Presentation B/W, color
- Digital Video Memory 1280 x 1024 / 24 bit
- Image Evaluation Functions B/W, HIGH, LOW, NEG; incl. Option HI-MAT, additionally VARI-MAT, O<sup>2</sup>, OS electronic zoom: stepless enlargement up to 16-times
- Monitor Flat Panel LCD Monitor

### Additional Features

- Features Luggage counter, user-id number, display of operating mode, Review-feature to recall previously visible image areas, zoom overview, free programmable keys
- Options HI-TIP, HI-SPOT, SEN, Xport, X-ACT, IMS (Image Management System)

### Installation Data

- X-ray Leakage meets all applicable laws & regulations w/ respect to X-ray emitting devices
- CE-Labeling in compliance with directives 2004/108/EC, 2006/42/EC, 2006/95/EC
- Sound Pressure Level < 56 dB(A)
- Operating / Storage Temperature 32°F - 104°F / -4°F - 140°F (0° - 40°C / -20°C - +60°C)
- Humidity 10% - 90% (non-condensing)
- Power Supply <sup>4)</sup> standard: 230 VAC or 110 VAC + 10% / -15% • 50 Hz / 60 Hz  $\pm$  3 Hz
- Power Consumption approx. 0.5 kVA
- Protection Class System IP 20
- Dimensions • Weight <sup>5)</sup> 1730 (L)<sup>2)</sup> x 797 (B) x 1180 (H) [mm] • approx. 340 kg  
68" (L)<sup>2)</sup> x 31.4" (B) x 46.5" (H) • approx. 748 lbs
- Mechanical Construction Steel construction with aluminum panels  
Standard color(s): RAL 7016 / stainless steel

<sup>1)</sup> approx. values (adjustable)

<sup>2)</sup> Different length of conveyor and mechanical access protection on request

<sup>3)</sup> Proprietary quality management test piece: steel step wedge, CU wires, belt speed 0.2 m/s

<sup>4)</sup> different values optional

<sup>5)</sup> without control desk, keyboard, monitor(s) etc.



**POINT SECURITY INC.**  
FIRST IN SECURITY SCREENING

[www.pointsecurityinc.com](http://www.pointsecurityinc.com)

Point Security, Inc.  
5815 NC Hwy 8 South  
Lexington, NC 27292  
1-800-476-1607



# Point Security, Inc.

5815 NC Hwy. 8 South  
Lexington, NC 27292  
(336) 357-3417

## Estimate

| Date      | Estimate # |
|-----------|------------|
| 1/18/2021 | 21-1065    |

| Customer:                          |
|------------------------------------|
| Tuscola Co., MI<br>Steven Anderson |

| Bid Number                                | Job   | Terms    | Decision Date | Sales Rep    | FOB         |
|---|---|----------|---------------|--------------|-------------|
|   |   | Net 30   | 2/17/2021     | Evan         | Destination |
| Item                                      | Description   | Quantity | Amount        | Total        |             |
| 6040DS                                    | POC: Steve Anderson<br>email: tcemanderson@tuscolacounty.org<br>Cell: 989-450-0147<br>Office: 989-673-5181<br><br>6040DS, X-Ray Inspection System<br>Smiths Detection<br>19"LCD<br>12 Month Standard Warranty<br>Hi-SPOT- Auto Dense Area Detection<br>Hi-TRAX- Image Enhancement Functions | 1.00     | 25,544.00     | 25,544.00T   |             |
| HEI-.5M-Di/DS                             | Table, .5M/20" Entry or Exit Roller<br>6040DS / 6030Di  | 1.00     | 850.00        | 850.00T      |             |
| HEI-1M-Di/DS                              | Table, 1M/40" Entry/Exit Roller<br>6040DS   | 1.00     | 950.00        | 950.00T      |             |
| HEI-Adv. HI-TraX                          | Advanced Software Package, \$10,800 value<br>HI-TIP-Plus - Treat Image Projection<br>OTS Xtrain - Operator Training System<br>IMS - Image Management System<br>Opti-ZOOM - Magnification Optimization<br>HDA - High Density Alert   | 1.00     | 2,500.00      | 2,500.00T    |             |
| Thank you for considering Point Security. |   |          |               | <b>Total</b> |             |





# Point Security, Inc.

5815 NC Hwy. 8 South  
 Lexington, NC 27292  
 (336) 357-3417

## Estimate

| Date      | Estimate # |
|-----------|------------|
| 1/18/2021 | 21-1065    |

| Customer:                          |
|------------------------------------|
| Tuscola Co., MI<br>Steven Anderson |

| Bid Number                                | Job   | Terms    | Decision Date | Sales Rep    | FOB         |
|---|---|----------|---------------|--------------|-------------|
|   |   | Net 30   | 2/17/2021     | Evan         | Destination |
| Item                                      | Description   | Quantity | Amount        | Total        |             |
| Installation X-Ray                        | Installation of X-Ray Inspection System<br>-Assembly, Testing and Final Commissioning<br>-Radiation Safety Inspection<br>-2-hour Operator Orientation by FSE  | 1.00     | 1,250.00      | 1,250.00     |             |
| Freight-Billed To Client                  | Freight, Shipping and Handling  | 1.00     | 900.00        | 900.00T      |             |
| PHEI-Warranty X-ray                       | On-Site Extended Warranty<br>w/ Annual PMI and Radiation Leak Survey<br>On-Site Coverage, M-F, 08:30-17:00<br>All Labor, Travel, Expenses<br>All replacement parts required   |          |               | 0.00T        |             |
| PHEI-Warranty4                            | On Site Ext. Warranty, Four Years (5 Total)   | 1.00     | 11,760.00     | 11,760.00T   |             |
|   | Are you sales tax exempt? Yes or No<br>If yes, please provide resale certificate or tax exempt number.<br>Sales Tax and Duties, if required, are not included in this pricing. Written documentation is required in order to waive sales tax. |          |               |              | 0.00        |
| Thank you for considering Point Security. |   |          |               | <b>Total</b> | \$43,754.00 |

Salvador Leanos  
to Steve

Option E

Good morning deputy Anderson,

At the current moment, I don't believe I can serve your needs with the L3 equipment. Getting to you is not a problem. I service Shiawassee County and other surrounding counties with their equipment. L3 parts are currently being shipped from China, I'm heavily tom from taking on the responsibility without the proper support.

There are other options we can consider. Let me know if you are interested in other options.

Thank You

Sal Leanos  
Advance Security Resources  
"Service is our business"



**IX. EDC Working Projects - (02-2021)**

1. Fremont Township Master Plan - Complete
2. Jet's Pizza - Downtown Caro
3. LaBudde Group Expansion Project - Working with DTE/Found Additional Space
4. MI-Tech Tooling In by April
5. Decker Equipment - Ribbon Cutting - Vassar
6. Putman Medical Clinic - help with Marketing, Opportunity Zones
7. Caro/Fox Dam - EGLE
8. Tuscola County Land Bank Organizational Meeting
9. Nestles Building Cass City -Interested Buyer
10. Millington Master Plan Update
11. All American Animal House - Apartment Rehab
12. Treadz Tire Relocation - Vassar
13. Downtown Caro - Telephone Poles Project
14. Re-Start Grant - Michigan EDC - All Checks Cashed
15. Frankenmuth Credit Union Grant
16. Small Business Relief Grant Paperwork
17. EPA Grant - New Application - (Done)
18. Millington Industrial Park - 2 lots sold - EDC Handling Paperwork
19. Update County Park and Recreation Plan
20. Thumb Tourism Website/EDC Web Views - 68,438 - continues to grow
21. Cass City DDA Report
22. Caro DDA Report
23. USDA Rural Business Enterprise Grant - Over \$50,000 available
24. Caro Farmers Market - Marketing
25. Broadband Planning Grant - Connect Michigan Surveys
26. LEAD Tuscola
27. Pioneer Work and Learn -Building possible lease or sale
28. New Restaurant - Downtown Vassar
29. I 69 Thumb Regional Meetings
30. New Caro Restaurant -former Mancino's location
31. Marketing of Organic Farming Products - Chinese
32. CDC Meetings
33. Working with Restart Grant Awardees- Final Reporting Requirements
34. Caro Center
35. Tuscola Municipal Manager's meeting
36. Met with possible buyer of former TACA building
37. DYNA Product - Lease Equipment delivered
38. 2 Large AG Business - Looking to Expand with \$10 Million investment
39. Co-op Elevator Company - \$2 Million Expansion in Fairgrove
40. Caro Building Evaluation for possible sale.
41. Saginaw Pizza - Looking for new location
42. State Savings Bank - Downtown Caro
43. Title Company - 141 S. Almer St., Caro
44. Major Manufacturer Company - New Product Line
45. Assist with Transfer of Ownership

# COVID19 Medical Claims Dashboard

Medical Claims Incurred and Paid 02/01/2020 - 01/29/2021

## TUSCOLA COUNTY

**175**

Unique Patients  
(with any COVID19 lab or Dx)

**\$2,212**

Total Patient Payment

**\$218,485**

Total Group Payment

**433**

Unique Claim Count



Percent of Claims by Claim Type

| Claim Type          | Claim Count | Unique Patients | Group Payment |
|---------------------|-------------|-----------------|---------------|
| ER                  | 0           | 0               | \$0           |
| Inpatient Facility  | 8           | 3               | \$161,193     |
| Outpatient Facility | 16          | 8               | \$13,170      |
| Professional        | 123         | 51              | \$18,275      |
| Telehealth          | 17          | 13              | \$1,672       |
| COVID19 Labs        | 312         | 162             | \$23,921      |
| Vaccine 1st Dose    | 11          | 11              | \$254         |
| Vaccine 2nd Dose    | 0           | 0               | \$0           |

Claim Type Count and Group Payment

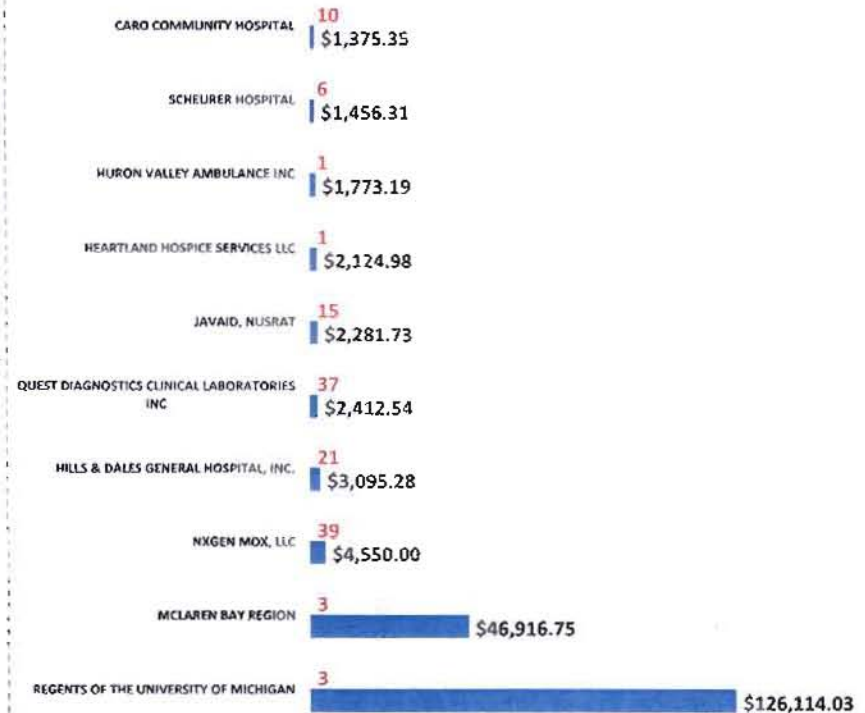

Top 10 Providers by Group Payment  
(Red = Number of Patients)

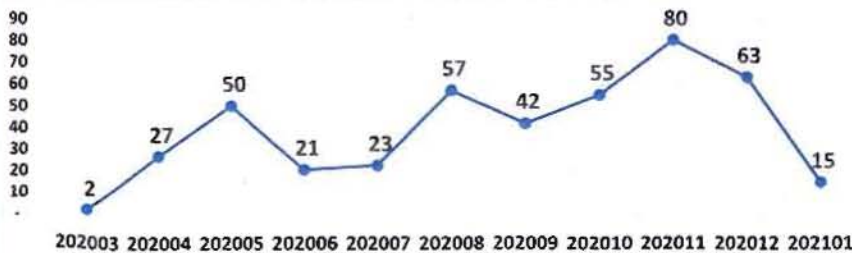

Claim Count by Month of Service

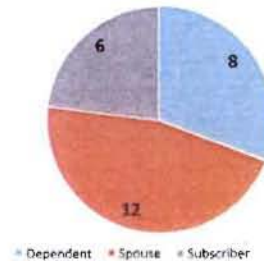

Confirmed Cases by Relationship

Suspected COVID19 Patient Count  
(Dx of Z2082B or Z03818)

**127**

Confirmed COVID19 Patient Count  
(Dx of U071 or B9729)

**26**

\*Dx1-Dx2 89729 (1/1/2020-3/31/2020) or Dx1 Z2082B, Z03818 or Dx1-Dx5 U071 or procedure codes U0001, U0002, U0003, U0004, G2023, G2024, 0001A, 0002A, 0011A, 0012A, 02021, 02231U, 0224U, 0240U, 0241U, 86118, 86328, 86413, 87428, 86769, 87426, 87635, 87636, 87637, 87811  
\*\*Telehealth claims include Blue Cross Online Visits if applicable for the group

# EXHIBIT A MAP SHOWING SUBJECT PROPERTY AREAS

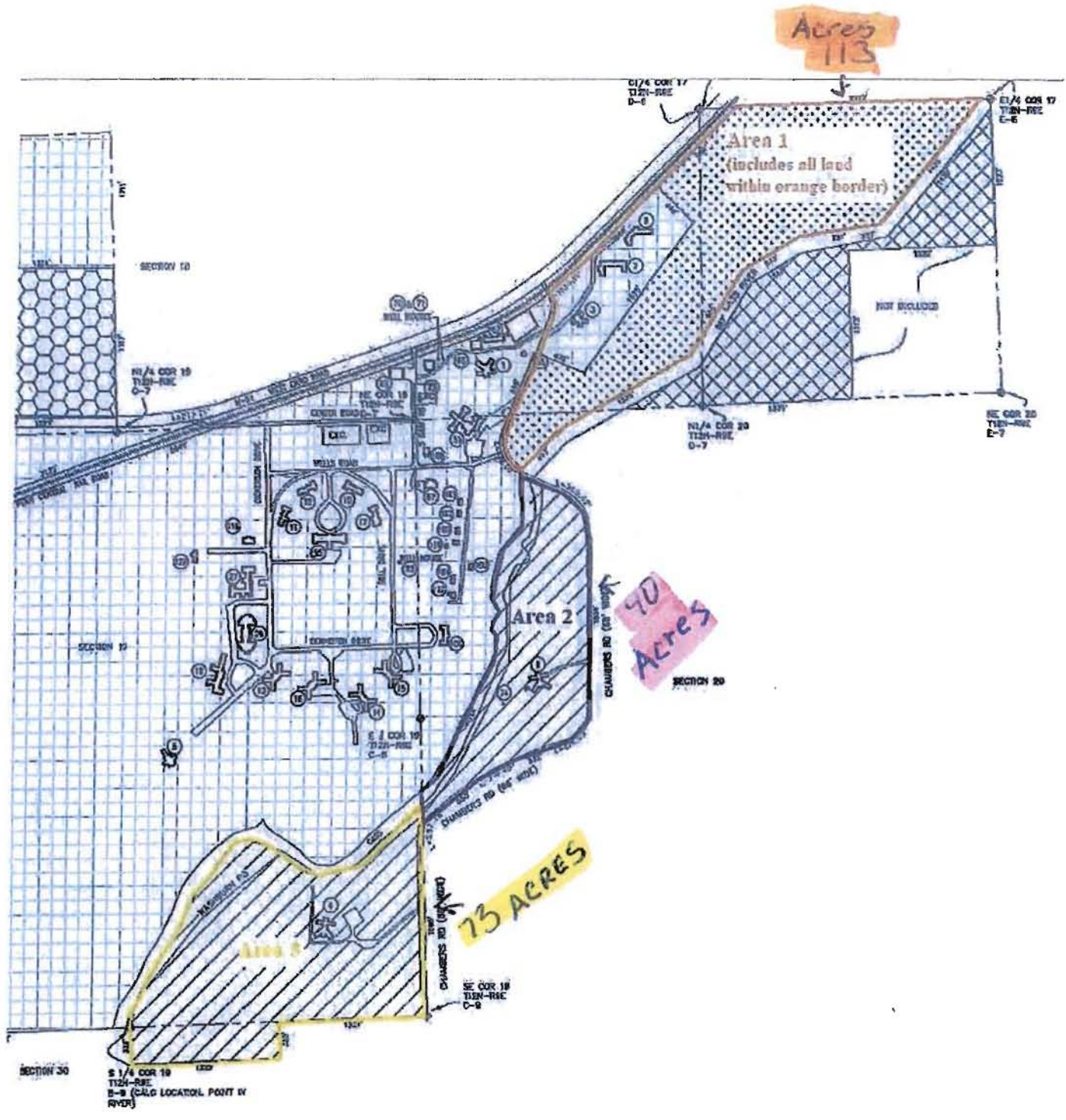



*Michigan Land Bank Fast Track Authority*

**EXHIBIT B  
AERIAL IMAGERY SHOWING SUBJECT PROPERTY AREAS**

*Composite Aerial*



**County Revenue Sharing Projections  
Executive Recommendation  
Fiscal Year 2022**

| <u>County</u>  | <u>County<br/>Revenue<br/>Sharing (CRS)</u> | <u>County<br/>Incentive<br/>Program (CIP)</u> | <u>Total County<br/>Projected<br/>Payment</u> |
|----------------|---|---|---|
| Alcona         | \$211,748.01                                | \$48,877.99                                   | \$260,626.01                                  |
| Alger          | \$166,114.71                                | \$38,344.41                                   | \$204,459.13                                  |
| Allegan        | \$1,948,829.14                              | \$449,850.05                                  | \$2,398,679.19                                |
| Alpena         | \$630,512.69                                | \$145,541.83                                  | \$776,054.53                                  |
| Antrim         | \$447,278.09                                | \$103,245.62                                  | \$550,523.70                                  |
| Arenac         | \$291,571.26                                | \$67,303.67                                   | \$358,874.93                                  |
| Baraga         | \$162,424.51                                | \$37,492.60                                   | \$199,917.12                                  |
| Barry          | \$994,176.94                                | \$229,486.79                                  | \$1,223,663.74                                |
| Bay            | \$2,238,839.00                              | \$516,793.30                                  | \$2,755,632.29                                |
| Benzie         | \$294,400.64                                | \$67,956.77                                   | \$362,357.41                                  |
| Berrien        | \$3,156,275.23                              | \$728,565.96                                  | \$3,884,841.19                                |
| Branch         | \$838,037.30                                | \$193,444.93                                  | \$1,031,482.23                                |
| Calhoun        | \$2,596,586.98                              | \$599,372.60                                  | \$3,195,959.57                                |
| Cass           | \$902,153.69                                | \$208,244.98                                  | \$1,110,398.67                                |
| Charlevoix     | \$510,649.21                                | \$117,873.63                                  | \$628,522.84                                  |
| Cheboygan      | \$488,871.38                                | \$112,846.64                                  | \$601,718.01                                  |
| Chippewa       | \$621,907.67                                | \$143,555.53                                  | \$765,463.20                                  |
| Clare          | \$559,140.05                                | \$129,066.82                                  | \$688,206.87                                  |
| Clinton        | \$1,156,055.26                              | \$266,853.31                                  | \$1,422,908.57                                |
| Crawford       | \$277,966.80                                | \$64,163.34                                   | \$342,130.14                                  |
| Delta          | \$694,969.63                                | \$160,420.49                                  | \$855,390.12                                  |
| Dickinson      | \$496,289.84                                | \$114,559.05                                  | \$610,848.88                                  |
| Eaton          | \$1,920,189.61                              | \$443,239.16                                  | \$2,363,428.77                                |
| Emmet          | \$0.00                                      | \$0.00  | \$0.00  |
| Grand Traverse | \$1,479,807.96                              | \$341,585.45                                  | \$1,821,393.42                                |
| Genesee        | \$8,562,658.98                              | \$1,976,526.57                                | \$10,539,185.55                               |
| Gladwin        | \$441,275.91                                | \$101,860.13                                  | \$543,136.04                                  |
| Gogebic        | \$293,583.77                                | \$67,768.22                                   | \$361,351.99                                  |
| Gratiot        | \$743,971.51                                | \$171,731.64                                  | \$915,703.15                                  |
| Hillsdale      | \$813,333.23                                | \$187,742.47                                  | \$1,001,075.70                                |
| Houghton       | \$591,271.50                                | \$136,483.75                                  | \$727,755.25                                  |
| Huron          | \$694,261.87                                | \$160,257.12                                  | \$854,518.99                                  |
| Ingham         | \$5,275,500.64                              | \$1,217,748.74                                | \$6,493,249.38                                |
| Ionia          | \$1,020,316.93                              | \$235,520.71                                  | \$1,255,837.64                                |
| Iosco          | \$460,404.66                                | \$106,275.64                                  | \$566,680.30                                  |
| Iron           | \$234,492.96                                | \$54,128.23                                   | \$288,621.19                                  |
| Isabella       | \$1,077,401.62                              | \$248,697.62                                  | \$1,326,099.24                                |
| Jackson        | \$2,922,314.95                              | \$674,560.69                                  | \$3,596,875.64                                |
| Kalamazoo      | \$4,495,790.97                              | \$1,037,767.63                                | \$5,533,558.59                                |
| Kalkaska       | \$302,325.17                                | \$69,786.00                                   | \$372,111.18                                  |
| Kent           | \$10,439,263.71                             | \$2,409,704.99                                | \$12,848,968.69                               |
| Keweenaw       | \$42,530.14                                 | \$9,817.27                                    | \$52,347.41                                   |
| Lake           | \$213,792.48                                | \$49,349.92                                   | \$263,142.40                                  |
| Lapeer         | \$1,448,293.39                              | \$334,310.92                                  | \$1,782,604.31                                |
| Leelanau       | \$404,540.23                                | \$93,380.40                                   | \$497,920.63                                  |
| Lenawee        | \$1,762,925.46                              | \$406,937.73                                  | \$2,169,863.19                                |
| Livingston     | \$2,693,889.80                              | \$621,833.10                                  | \$3,315,722.90                                |
| Luce           | \$111,191.70                                | \$25,666.48                                   | \$136,858.18                                  |



101-000-574-253

County Revenue Sharing Projections  
Executive Recommendation  
Fiscal Year 2022

10/1/2021 -  
9/30/2022

| <u>County</u> | <u>County Revenue Sharing (CRS)</u> | <u>County Incentive Program (CIP)</u> | <u>Total County Projected Payment</u> |
|---------------|-------------------------------------|---------------------------------------|---------------------------------------|
| Mackinac      | \$225,100.09                        | \$51,960.06                           | \$277,060.15                          |
| Macomb        | \$14,237,719.92                     | \$3,286,506.18                        | \$17,524,226.10                       |
| Manistee      | \$472,321.47                        | \$109,026.41                          | \$581,347.88                          |
| Marquette     | \$1,105,289.36                      | \$255,134.97                          | \$1,360,424.33                        |
| Mason         | \$544,946.28                        | \$125,790.46                          | \$670,736.74                          |
| Mecosta       | \$737,810.42                        | \$170,309.47                          | \$908,119.89                          |
| Menominee     | \$459,898.85                        | \$106,158.88                          | \$566,057.74                          |
| Midland       | \$1,711,106.48                      | \$394,976.31                          | \$2,106,082.78                        |
| Missaukee     | \$245,806.16                        | \$56,739.67                           | \$302,545.83                          |
| Monroe        | \$2,689,592.02                      | \$620,841.04                          | \$3,310,433.06                        |
| Montcalm      | \$1,076,550.25                      | \$248,501.10                          | \$1,325,051.35                        |
| Montmorency   | \$187,181.00                        | \$43,207.17                           | \$230,388.17                          |
| Muskegon      | \$3,120,109.98                      | \$720,217.90                          | \$3,840,327.88                        |
| Newaygo       | \$826,675.05                        | \$190,822.17                          | \$1,017,497.23                        |
| Oakland       | \$22,669,248.20                     | \$5,232,763.73                        | \$27,902,011.93                       |
| Oceana        | \$464,005.76                        | \$107,106.88                          | \$571,112.64                          |
| Ogemaw        | \$398,781.73                        | \$92,051.16                           | \$490,832.89                          |
| Ontonagon     | \$150,129.21                        | \$34,654.47                           | \$184,783.68                          |
| Osceola       | \$491,103.10                        | \$113,361.79                          | \$604,464.89                          |
| Oscoda        | \$170,153.95                        | \$39,276.80                           | \$209,430.75                          |
| Otsego        | \$425,274.40                        | \$98,166.49                           | \$523,440.88                          |
| Ottawa        | \$4,061,995.07                      | \$937,634.11                          | \$4,999,629.18                        |
| Presque Isle  | \$271,714.48                        | \$62,720.11                           | \$334,434.58                          |
| Roscommon     | \$439,771.15                        | \$101,512.79                          | \$541,283.94                          |
| Saginaw       | \$3,956,482.95                      | \$913,278.65                          | \$4,869,761.61                        |
| Sanilac       | \$793,810.94                        | \$183,236.12                          | \$977,047.06                          |
| Schoolcraft   | \$160,024.18                        | \$36,938.53                           | \$196,962.71                          |
| Shiawassee    | \$1,248,840.12                      | \$288,270.93                          | \$1,537,111.05                        |
| St Clair      | \$3,252,938.76                      | \$750,878.89                          | \$4,003,817.66                        |
| St Joseph     | \$1,190,052.73                      | \$274,700.98                          | \$1,464,753.71                        |
| Tuscola       | \$950,817.61                        | \$219,478.12                          | \$1,170,295.72                        |
| Van Buren     | \$1,332,686.86                      | \$307,625.35                          | \$1,640,312.21                        |
| Washtenaw     | \$5,985,252.45                      | \$1,381,581.41                        | \$7,366,833.87                        |
| Wayne         | \$43,332,294.72                     | \$10,002,434.05                       | \$53,334,728.77                       |
| Wexford       | \$582,109.65                        | \$134,368.91                          | \$716,478.56                          |
| <b>Totals</b> | <b>\$188,097,722.55</b>             | <b>\$43,418,772.91</b>                | <b>\$231,516,495.46</b>               |

Actual 2019 - 958,315  
 Actual 2020 - 878,817  
 Bdg - 2021 - 1,147,447  
 Est Bdg - 2022 - 1,170,295 1.99%↑

**9-1-1**

F.

**Tuscola County Central Dispatch**

Sandra Nielsen, Director

February 12, 2021

From: Sandra Nielsen, Director  
Subject: Hiring of Dispatcher  
To: Tuscola County Board of Commissioners

Dear Commissioners,

I respectfully request the Board of Commissioners to concur with hiring Kaitlyn Bennett as a full time dispatcher effective February 28, 2021. This request is to fill a vacant full time dispatcher positions and all pre-employment criteria has been completed.

Central Dispatch has the required funds in the budget to fill this position. The dispatch operating fund comes from 911 telephone surcharge and does not affect the general fund. Full staffing is essential in providing 9-1-1 communications services to the county and the community.

Thank you,



Sandra Nielsen, Director  
Tuscola County Central Dispatch

G.



TUSCOLA

*Behavioral Health Systems*

February 10, 2021

Tuscola County Board of Commissioners  
125 West Lincoln, Suite 500  
Caro, MI 48723

Dear Commissioners,

As you are aware, the current terms of several members of the Tuscola Behavioral Health Systems Board of Directors will be expiring as of March 31, 2021. Current contact information is enclosed.

At its regularly scheduled Board Meeting of January 28, 2021, the Tuscola Behavioral Health Systems Board of Directors resolved to recommend to the Tuscola County Board of Commissioners, the re-appointments of Mr. Thomas Bardwell, Ms. Marianne Harrington, and Ms. Brenda Ryan to our Board of Directors for a three-year term.

As always, we appreciate your strong support of our efforts and thank you in advance for your consideration of these recommendations.

Sincerely,

Sharon Beals  
Chief Executive Officer

SB/clm

Enclosure

cc: Jody Fetting, Tuscola County Clerk

---

*A Michigan Community Mental Health Authority serving Tuscola County since 1973*

Mailing and Administration Address: 323 North State Street, Caro, MI 48723

Clinical Programs located at 1332 Propect Avenue, Caro, MI 48723

989.673.6191 or 1.800.462.6814 • TDD 1.866.835.4186 • [www.tbhsonline.com](http://www.tbhsonline.com)



**RECOMMENDED RE-APPOINTMENTS FOR  
TUSCOLA BEHAVIORAL HEALTH SYSTEMS  
BOARD OF DIRECTORS**

Thomas Bardwell  
3540 North Hurds Corner Road  
Caro, MI 48723

989-673-0409 (Home)  
989-325-2678 (Work/Cell)  
tbardwell@tuscolacounty.org

Marianne Harrington  
8725 State Road, Apt. A2  
Millington, MI 48746

989.871.2881 (Home)  
mariharrington59@gmail.com

Brenda Ryan  
4265 Beach Street, PO Box 53  
Akron, MI 48701

989.691.5300 (Home)  
brendaryan5300@yahoo.com



Tuscola County

Clayette Zechmeister &lt;zclay@tuscolacounty.org&gt;

---

**Land Bank Appointment Request**

1 message

Jodi Fetting &lt;jfetting@tuscolacounty.org&gt;

Wed, Feb 17, 2021 at 9:51 AM

To: Clayette <zclay@tuscolacounty.org>, Dan Grimshaw <dgrimshaw@tuscolacounty.org>, Doug DuRussel <ddurussel@tuscolacounty.org>, Kim Vaughan <kvaughan@tuscolacounty.org>, Thomas Bardwell <tbardwell@tuscolacounty.org>, Tom Young <tyoung@tuscolacounty.org>, Tom Young <ctayoung@hotmail.com>, Ashley Bennett <abennett@tuscolacounty.org>

Good Morning,

At the Committee of the Whole meeting on Monday, February 22, 2021, the topic of appointment to the Tuscola County Land Bank will be up for discussion.

There have been three people that have applied to be considered for the appointment which is a 3-year term beginning on March 1, 2021.

The applicants:

1. John Tilt - Current Board Member
2. Douglas Waineo
3. Andrew Niedzinski

Thank you for your attention to this matter.

Clerk Fetting

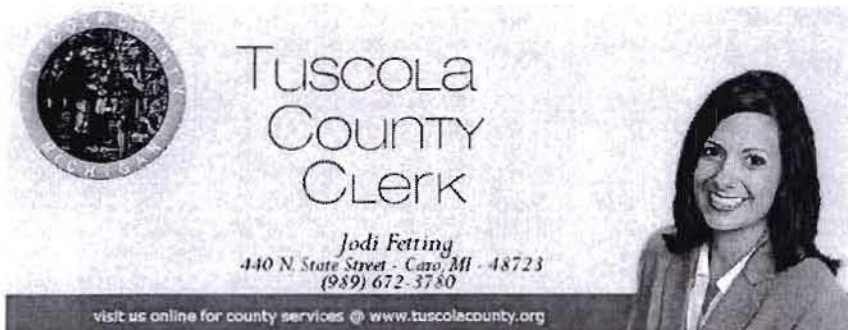
*faxed to Commissioner Grimshaw*

---

20210217\_CtiLssCijj.pdf  
373K

